

Edixeon S1 Single Color Series Datasheet



Features :

- Various colors
- More energy efficient than incandescent and most halogen lamps
- Low voltage operation
- Instant light
- Long operating life

Table of Contents

General Information.....	3
Absolute Maximum Ratings.....	4
Characteristics.....	4
Luminous Flux Characteristic.....	5
Mechanical Dimensions.....	6
Characteristic curve.....	7
Reflow Profile.....	35
Reliability.....	36
Product Packaging Information.....	37
Revision History.....	38
About Edison Opto.....	38

General Information

Introduction

Edixeon S1 series emitters are one of the highest flux LEDs in the world by Edison Opto. Edixeon S1 series emitters are designed to satisfy more and more Solid-State lighting High Power LED applications for brilliant world such as flash light, indoor and outdoor decoration light. Unlike most fluorescent sources, Edixeon Opto contains no mercury and has more energy efficient than other incandescent light source.

Ordering Code Format

<u>2</u> X1	<u>E</u> X2	<u>S 1</u> X3	<u>0 x</u> X4	<u>x X</u> X5	<u>x x</u> X6	<u>0 0 0</u> X7	<u>x x x</u> X8		
X1	X2		X3		X4		X5		
Type	Component		Series		Wattage		Color		
2	Emitter	E	Edixeon	S1	S1 Series	01 03	1W 3W	RX TX BX AX	Red True Green Blue Amber
X6		X7	X8						
Internal code		PCB Board	Serial Number						
-		-	000	-	-	-			

Absolute Maximum Ratings

Parameter	Symbol	Value	Units
DC Forward Current ^[1]	(1W) (3W) I_F	350 700	mA
Peak Pulsed Current; (tp≤100μs, Duty cycle=0.25) ^[2]	(1W) (3W) I_{pulse}	500 1000	mA
Reverse Voltage	V_R	5	V
Drive Voltage	V_D	5	V
LED Junction Temperature ^[3]	T_J	125	°C
Operating Temperature	-	-30 ~ +110	°C
Storage Temperature	-	-40 ~ +120	°C
ESD Sensitivity (HBM)	-	2,000	V
Manual Soldering Time at 260°C(Max.)	-	5	Sec.

Notes:

1. Proper current derating must be observed to maintain junction temperature below the maximum at all time.
2. LEDs are not designed to be driven in reverse bias.
3. tp: Pulse width time

Characteristics

Parameter	Symbol	Value	Units
Viewing Angle	(R/A) (T/B) $2\Theta_{1/2}$	135 150	Degree
Forward voltage	(Typ.) V_F	1W - R/A : 2.3 1W - T/B : 3.2 3W - R/A : 2.5 3W - T/B : 3.5	V
Thermal resistance	-	11	°C/W
$\Delta V_F / \Delta T$	$\Delta V_F / \Delta T$	-2	mV/°C
Wavelength	λ_d	R: 620-630 A: 585-595 T: 515-535 B: 455-475	nm
JEDEC Moisture Sensitivity	-	Level 2a Floor Life Conditions: ≤30°C / 60% RH Soak Requirements(Standard) Time (hours): 120+1/-0 Conditions: 60°C / 60% RH	-

Notes:

1. Dominant Wavelength is measured with an accuracy of ± 1nm.
2. Viewing angle is measured with an accuracy of ± 5%.

Luminous Flux Characteristic

Luminous Flux Characteristics at $T_j=25^{\circ}\text{C}$.

Color	Wattage (W)	Group	Min. Luminous Flux(lm)	Max. Luminous Flux(lm)	Forward Current (mA)	Order Code
Red	1	R0	39.4	51.2	350	2ES101RX00000001
		S0	51.2	66.5		
	3	U0	86.5	110	700	2ES103RX00000001
		V0	110	160		
True Green	1	T0	66.5	86.5	350	2ES101TX00000001
		U0	86.5	110		
		V0	110	160		
	3	U0	86.5	110	700	2ES103TX00000001
		V0	110	160		
		W1	160	180		
		W2	180	200		
		W3	220	220		
X1	220	240				
Blue	1	N0	17.9	23.3	350	2ES101BX00000001
		P0	23.3	30.3		
		Q0	30.3	39.4		
	3	Q0	30.3	39.4	700	2ES103BX00000001
		R0	39.4	51.2		
Amber	1	S0	51.2	66.5	350	2ES101AX00000001
		T0	66.5	86.5		
	3	U0	86.5	110	700	2ES103AX00000001
		V0	110	160		

Notes:

1. Flux is measured with an accuracy of $\pm 10\%$.
2. True Green and Blue emitters are built with InGaN.
3. All Red emitters are built with AlGaInP.

Mechanical Dimensions

Emitter Type Dimension

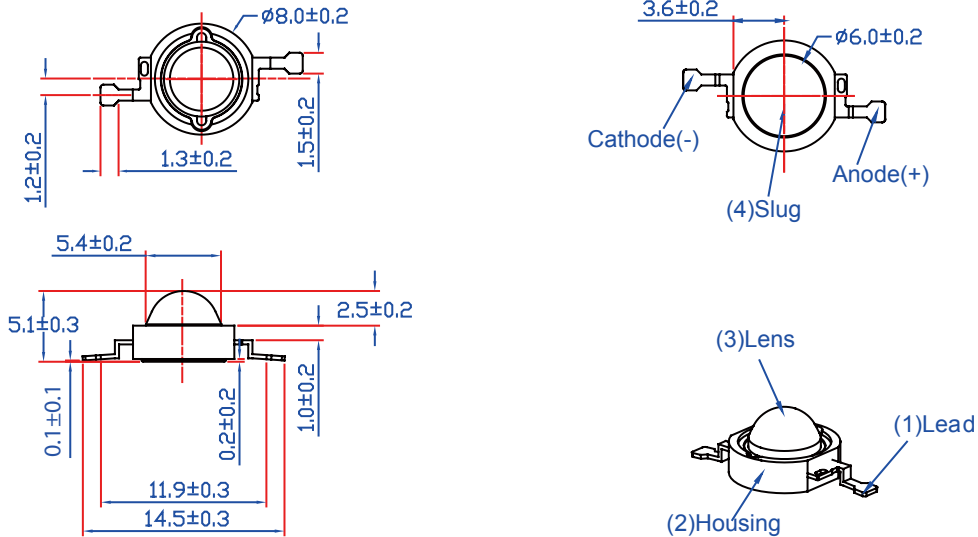

Star Dimensions

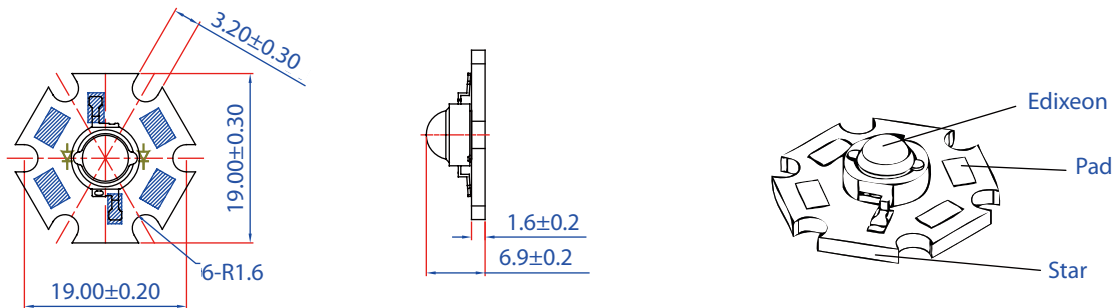

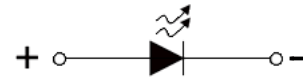
Emitter color	Slug at the bottom of the electrode	Circuit
R/A	Anode	
T/B	No electrode	

Notes:

1. All dimensions are in mm.
2. Lambertian and side emitting series slug has polarity as anode.
3. It is important that the slug can't contact aluminum surface, It is strongly recommended that there should coat a uniform electrically isolated heat dissipation film on the aluminum surface.

Characteristic curve

Color Spectrum

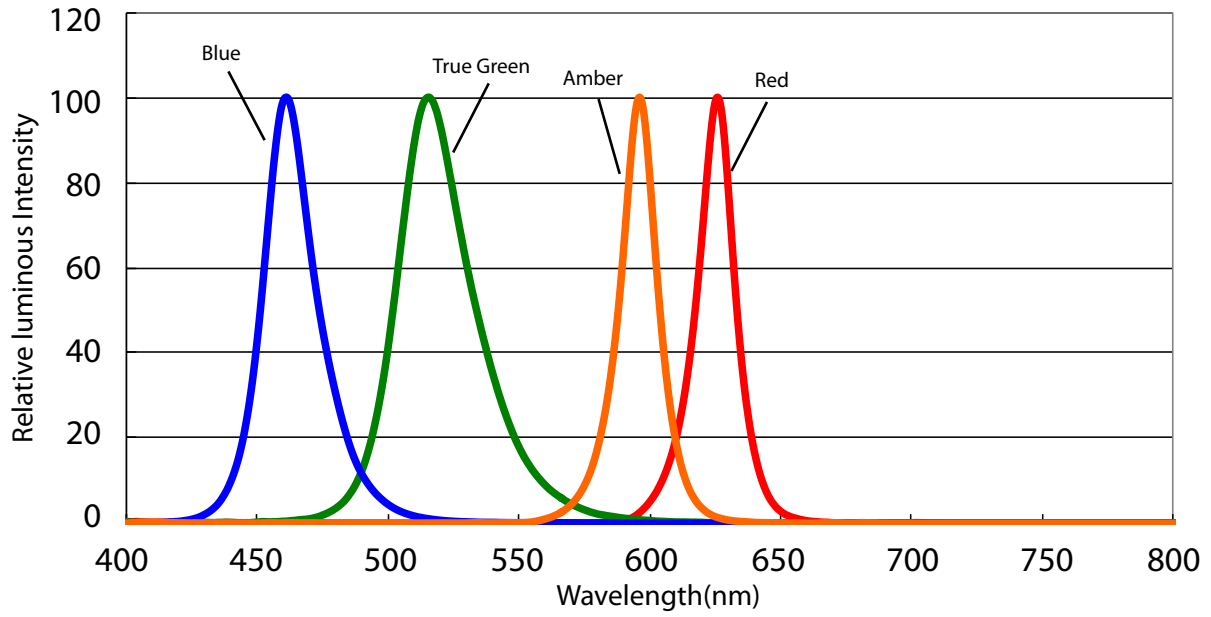

Beam Pattern (Red, Amber)

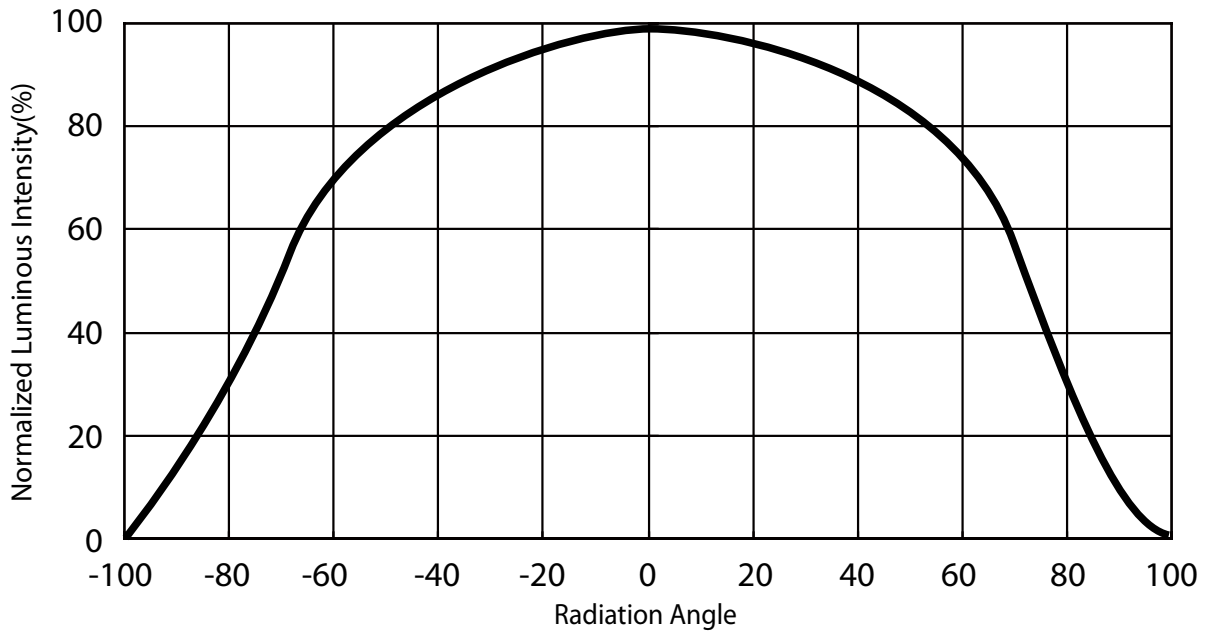

Beam Pattern (Blue, True Green)

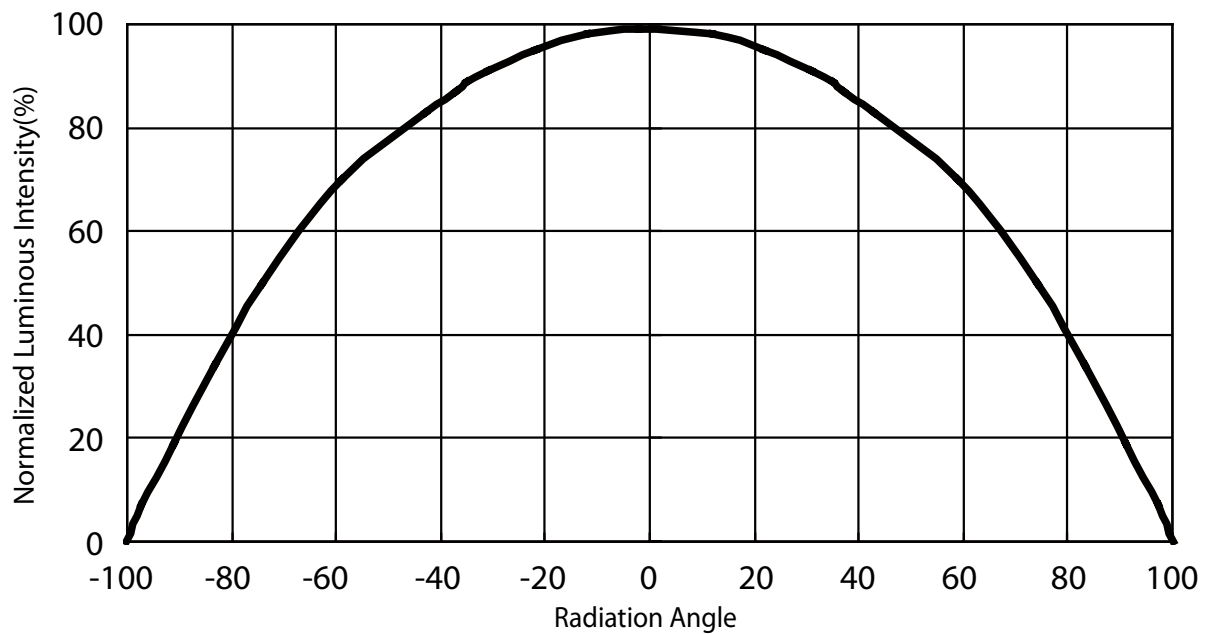

Forward Current vs. Forward Voltage (1W Red)

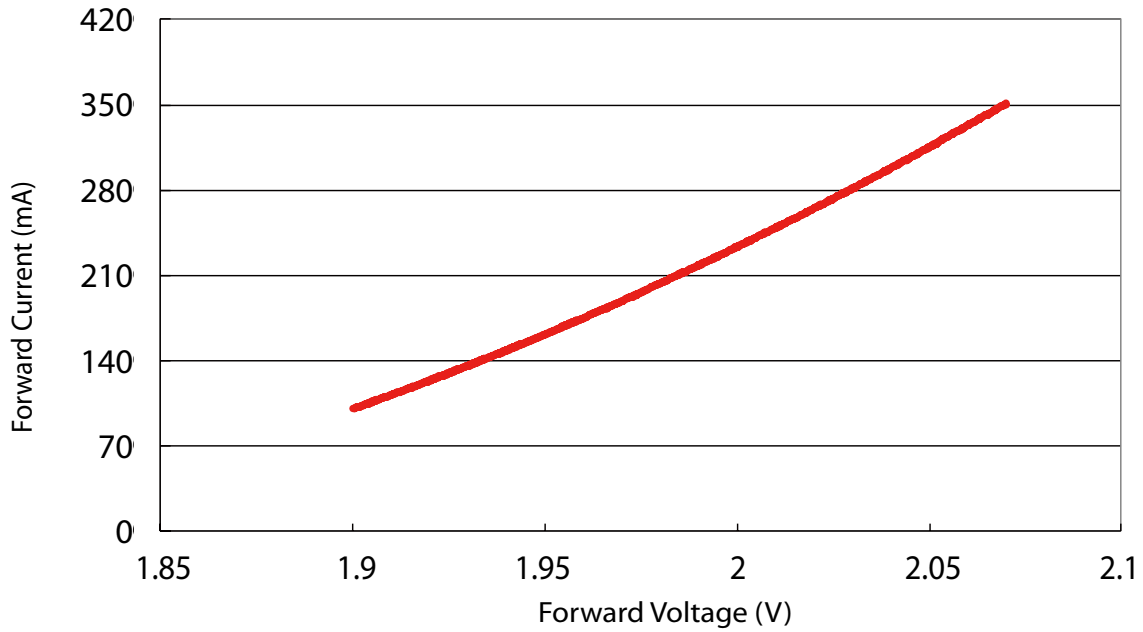

Forward Current vs. Forward Voltage (1W True Green)

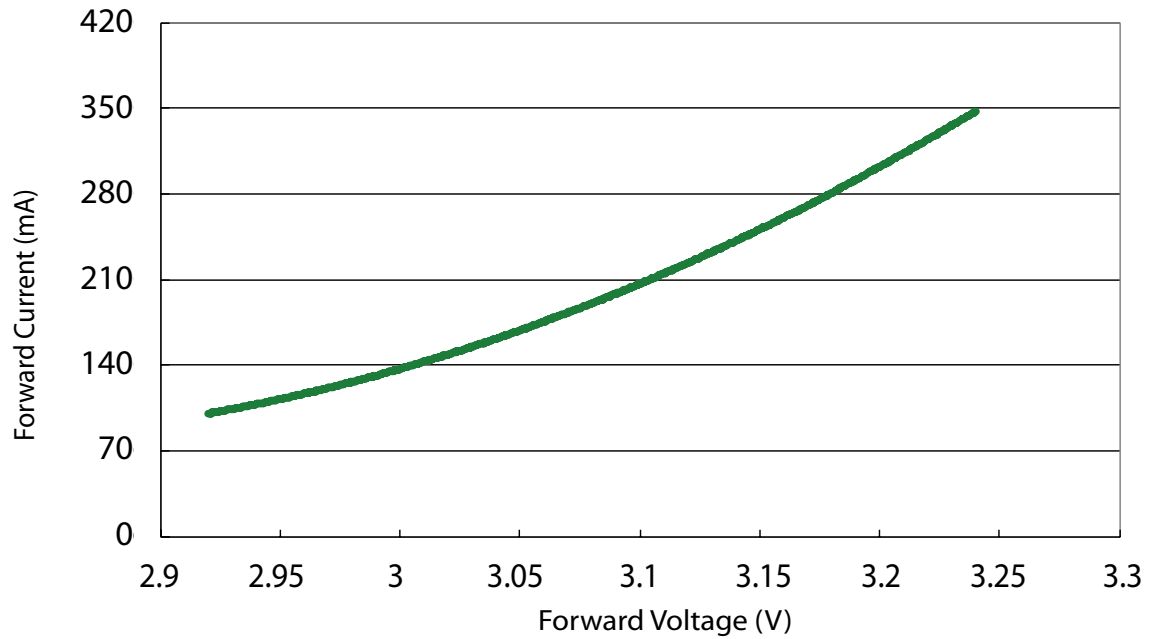

Forward Current vs. Forward Voltage (1W Blue)

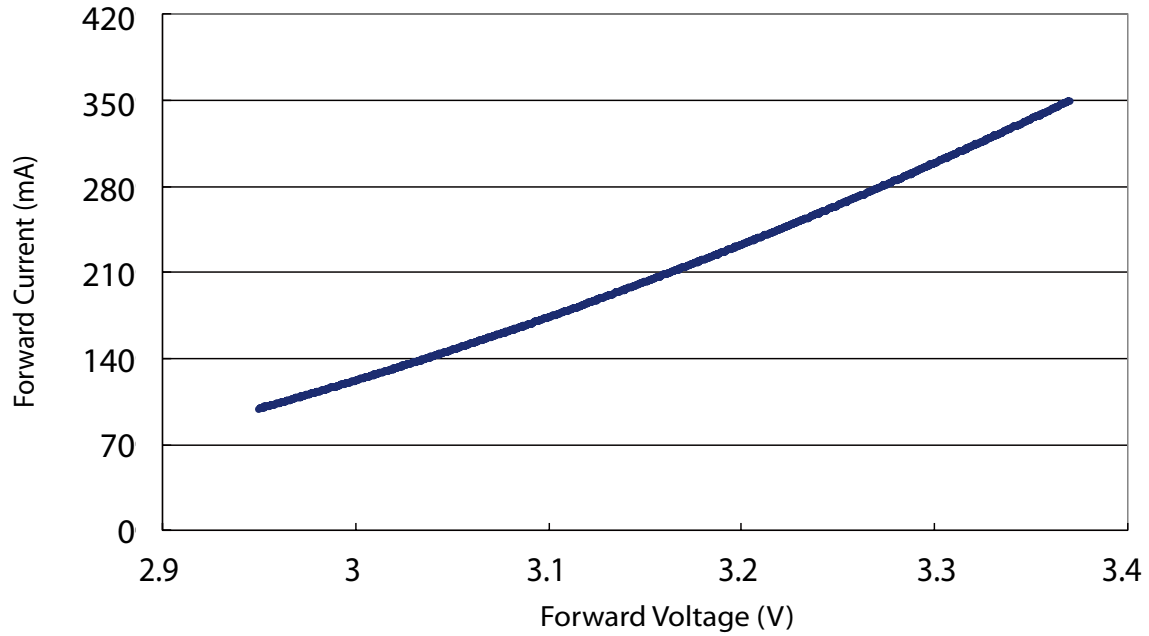

Forward Current vs. Forward Voltage (1W Amber)

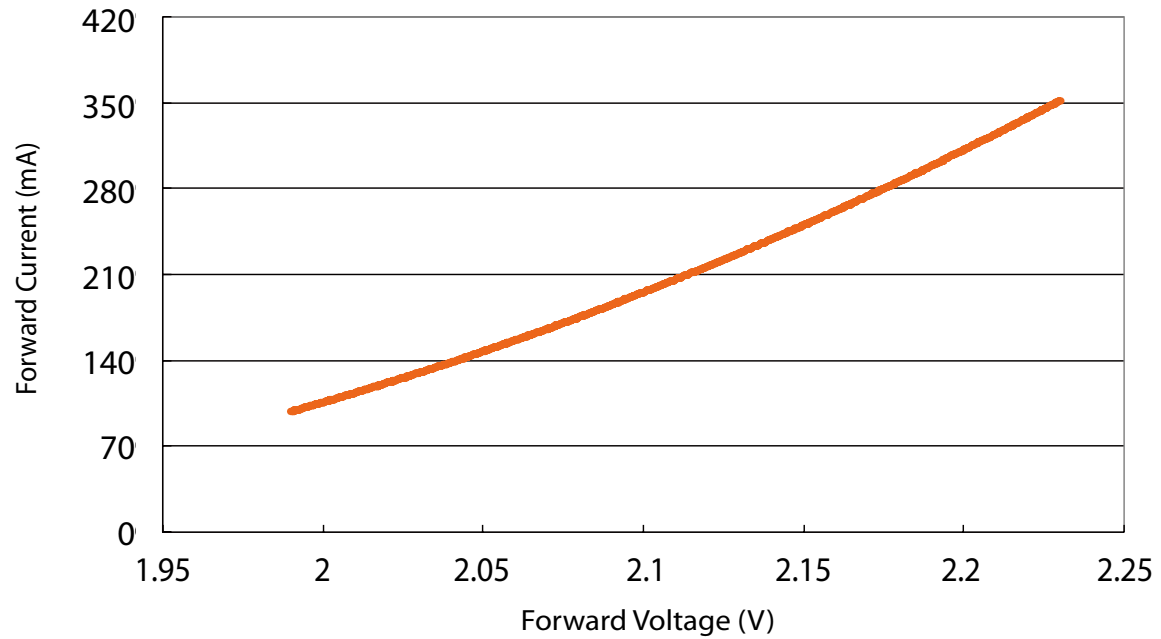

Forward Current vs. Forward Voltage (3W Red)

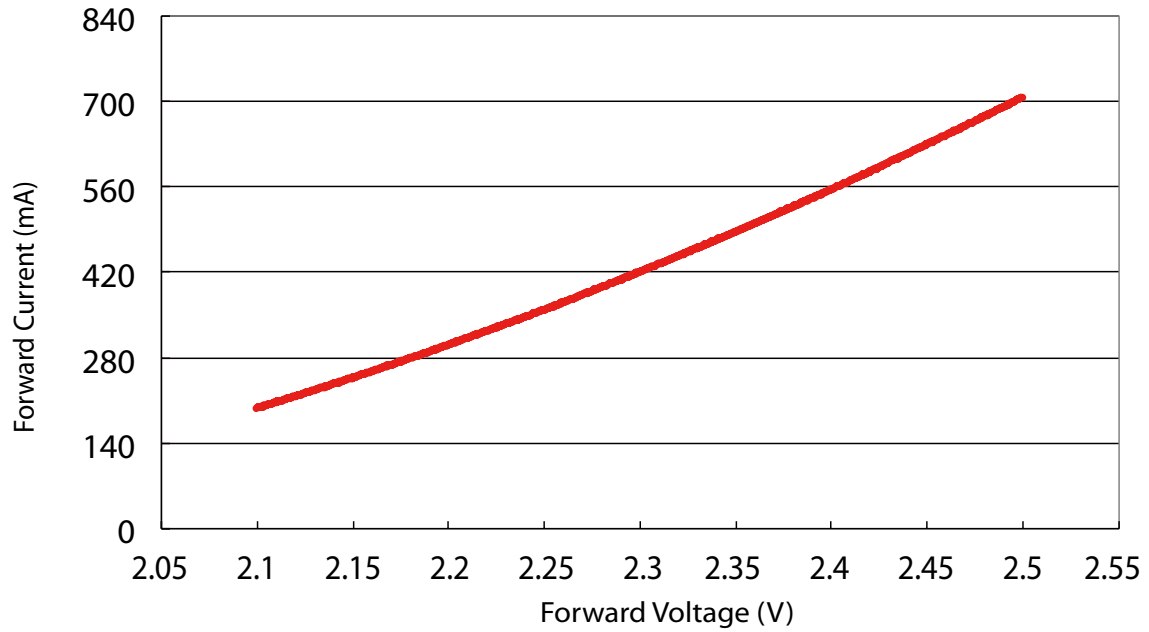

Forward Current vs. Forward Voltage (3W True Green)

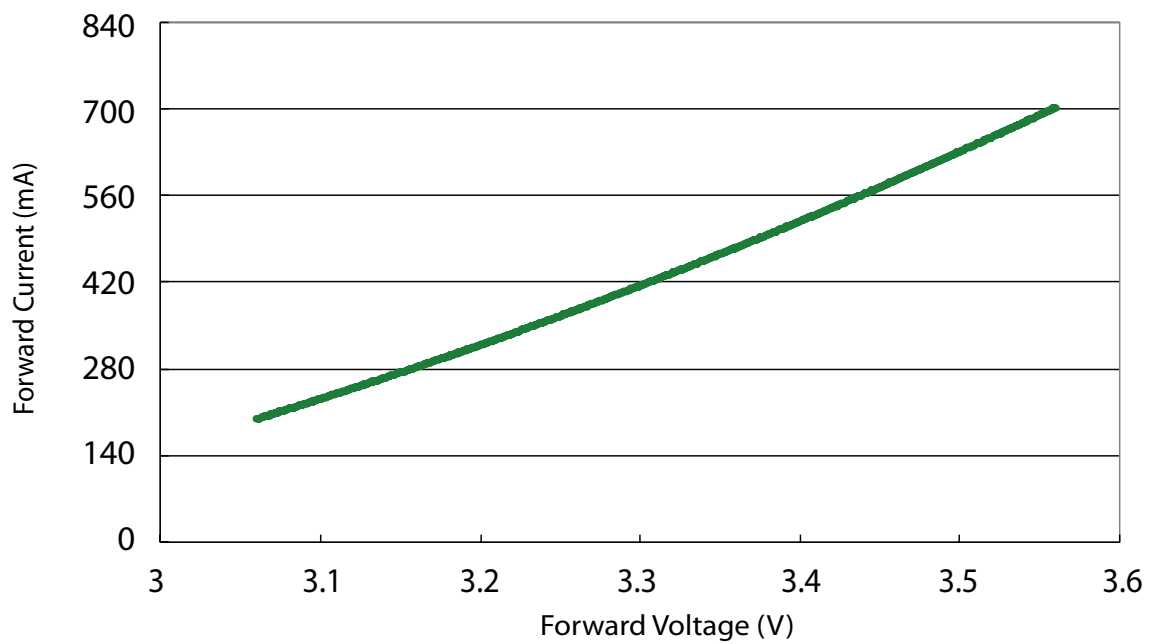

Forward Current vs. Forward Voltage (3W Blue)

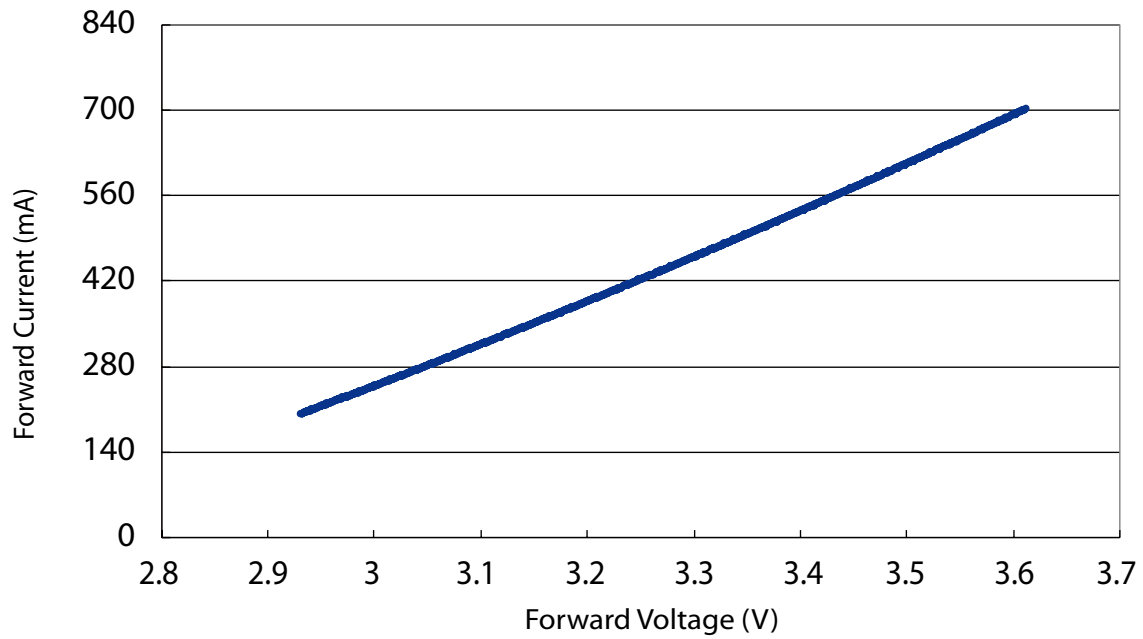

Forward Current vs. Forward Voltage (3W Amber)

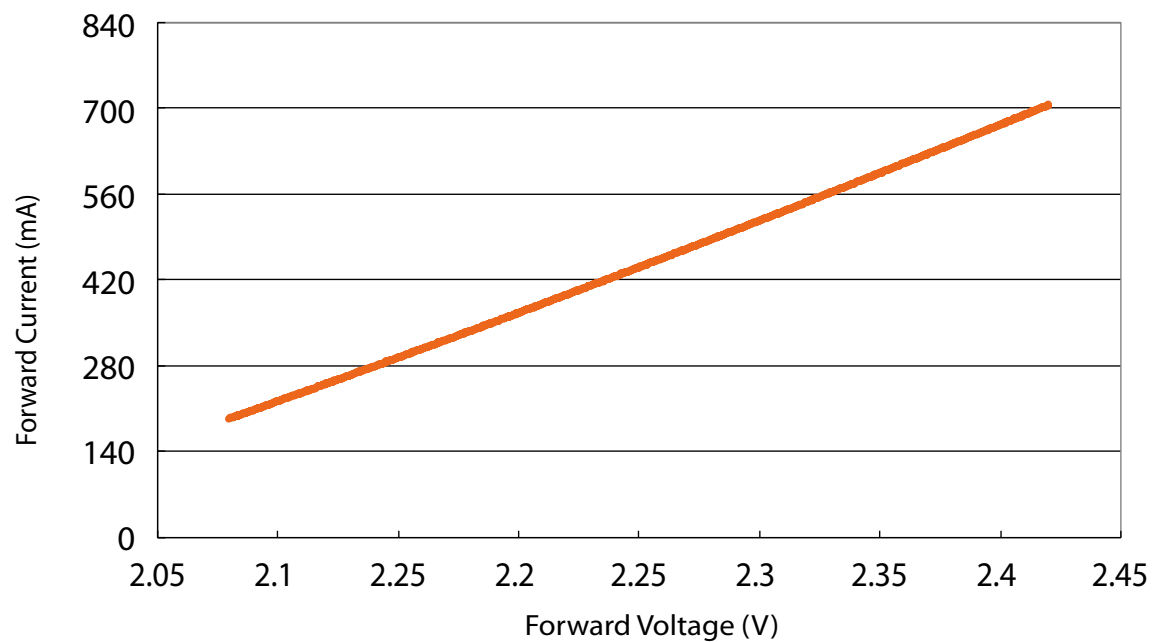

Relative Luminous Intensity vs. Forward Current (1W Red)

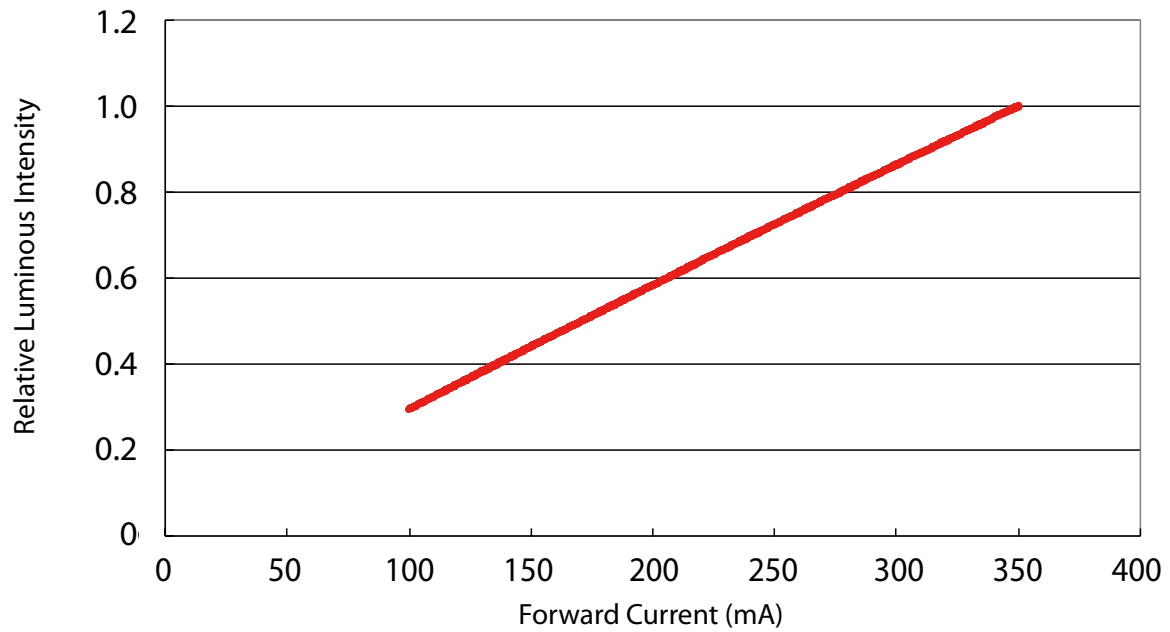

Relative Luminous Intensity vs. Forward Current (1W True Green)

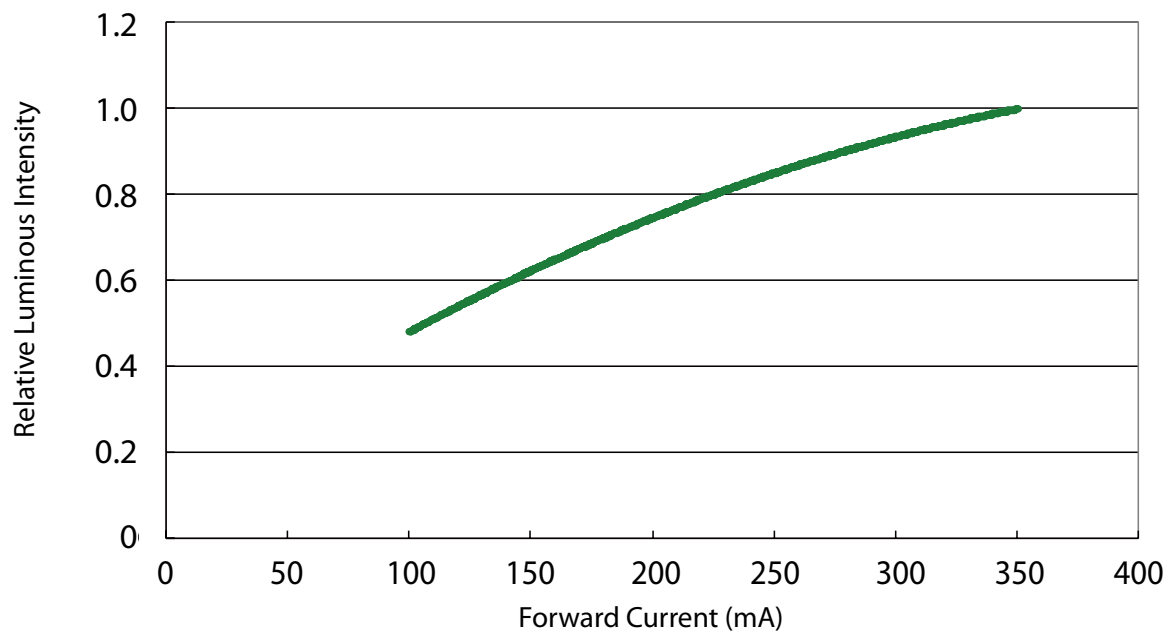

Relative Luminous Intensity vs. Forward Current (1W Blue)

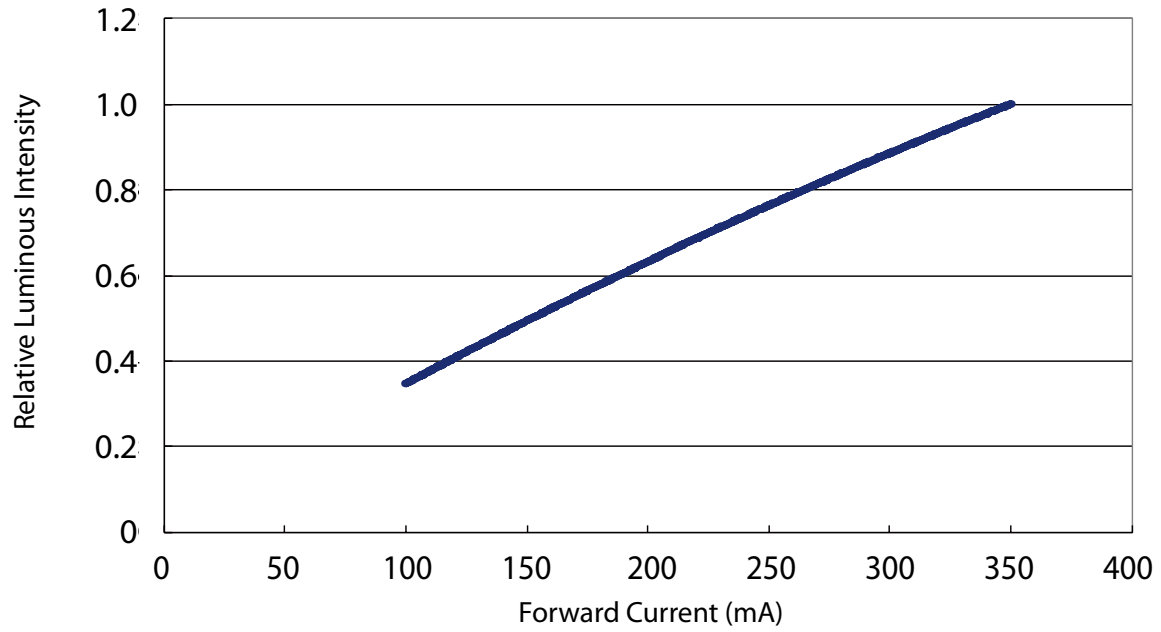

Relative Luminous Intensity vs. Forward Current (1W Amber)

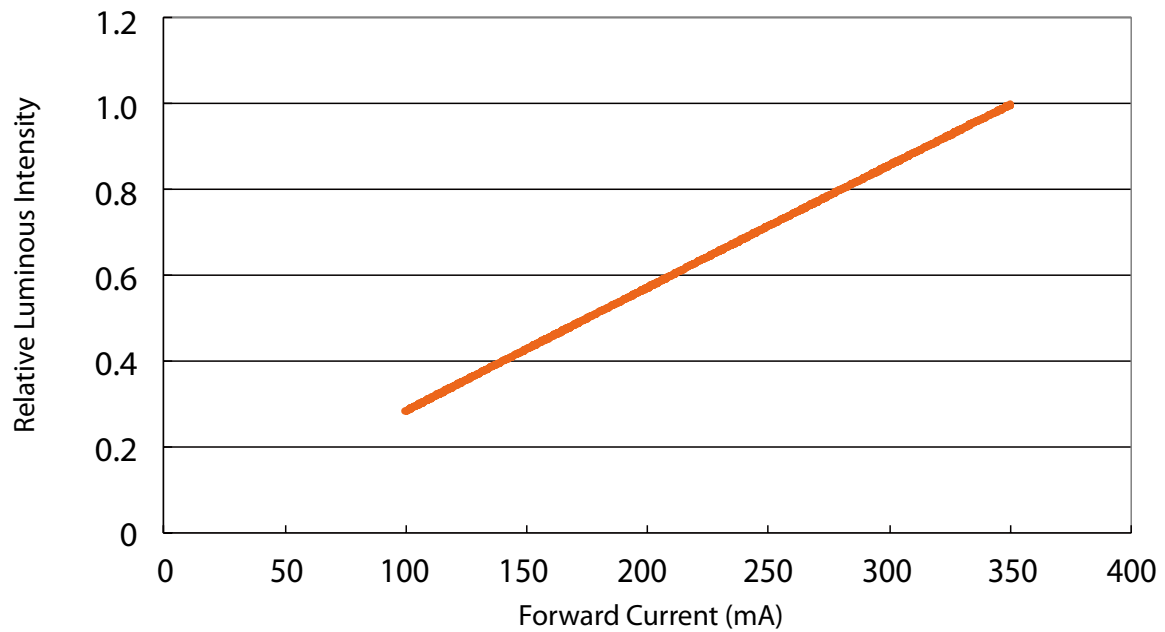

Relative luminous Intensity vs. Forward Current (3W Red)

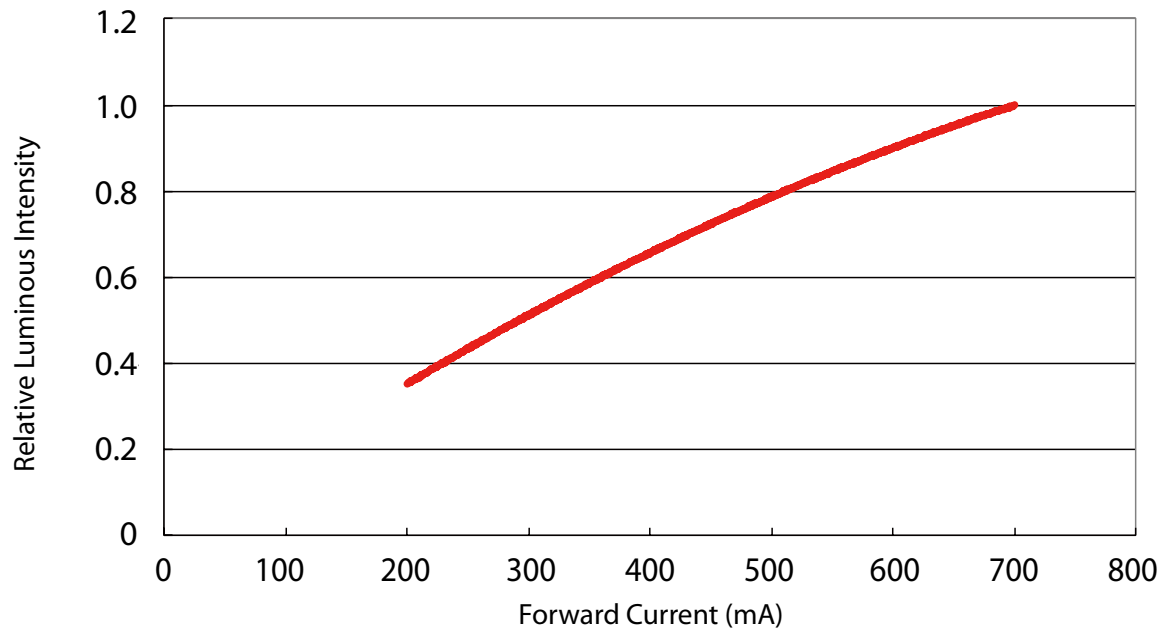

Relative luminous Intensity vs. Forward Current (3W True Green)

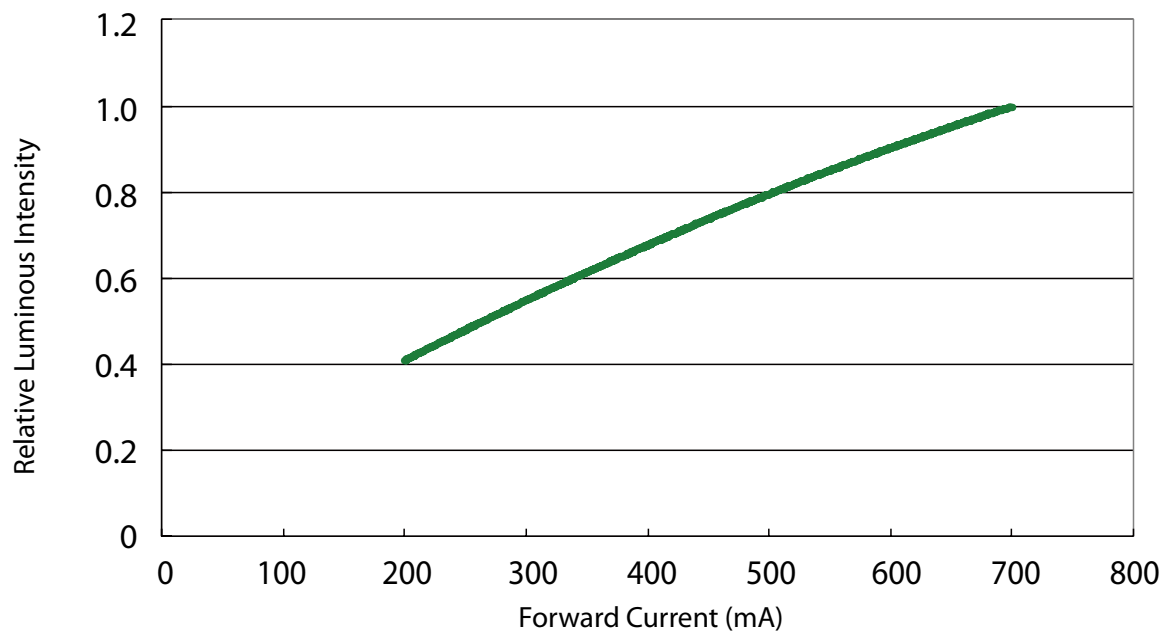

Relative luminous Intensity vs. Forward Current (3W Blue)

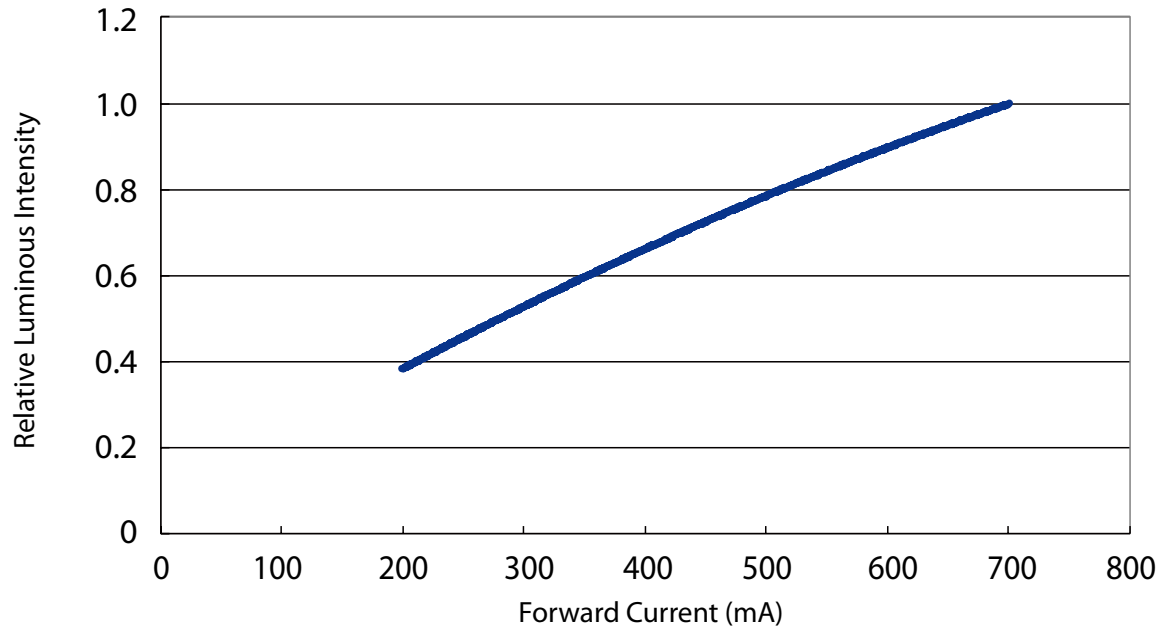

Relative luminous Intensity vs. Forward Current (3W Amber)

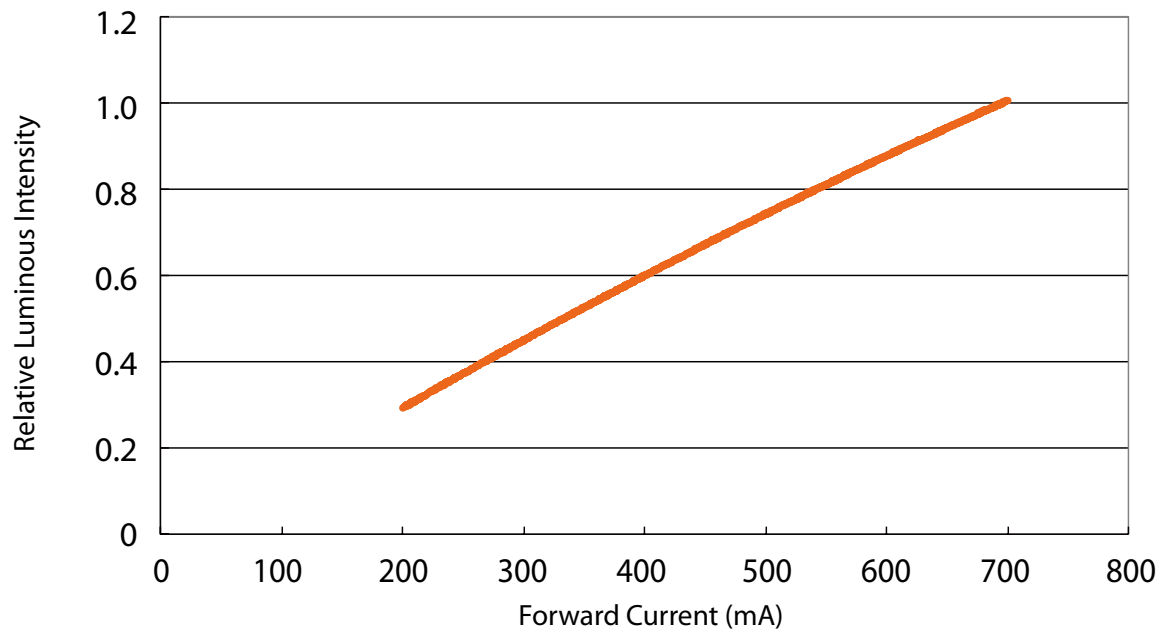

Relative Luminous intensity vs. Junction Temperature (1W Red)

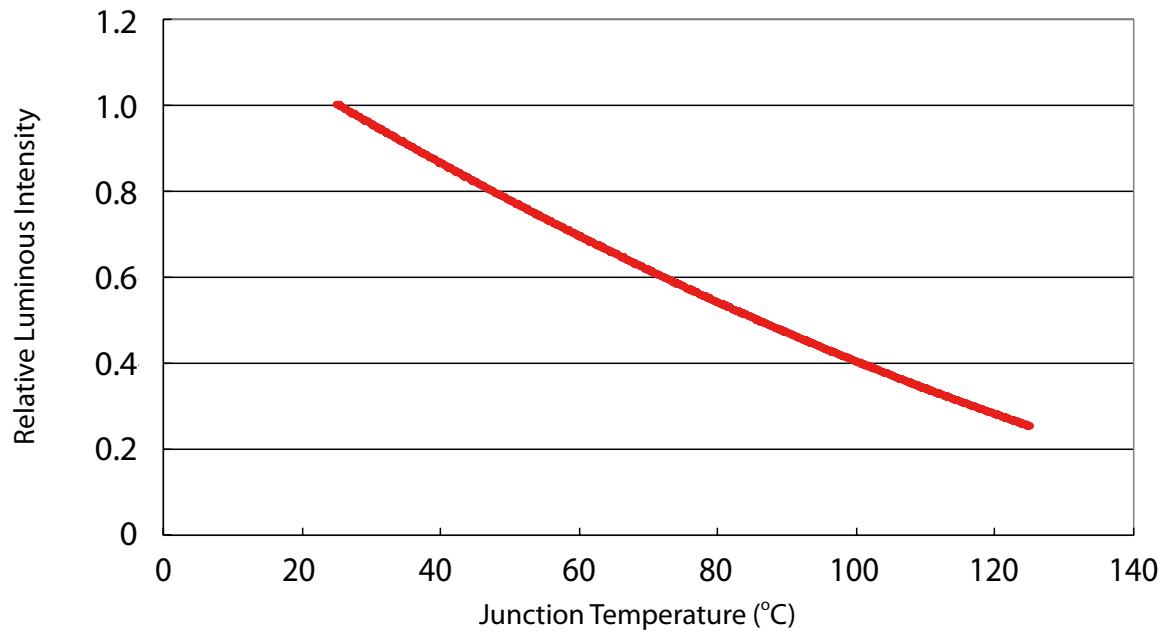

Relative Luminous intensity vs. Junction Temperature (1W True Green)

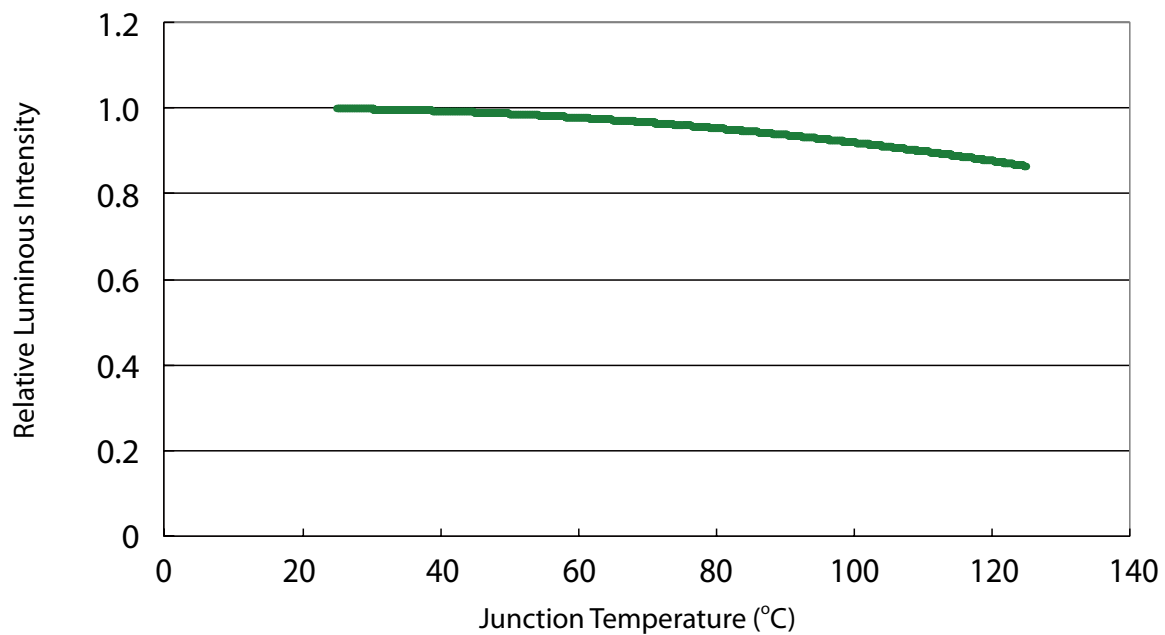

Relative Luminous intensity vs. Junction Temperature (1W Blue)

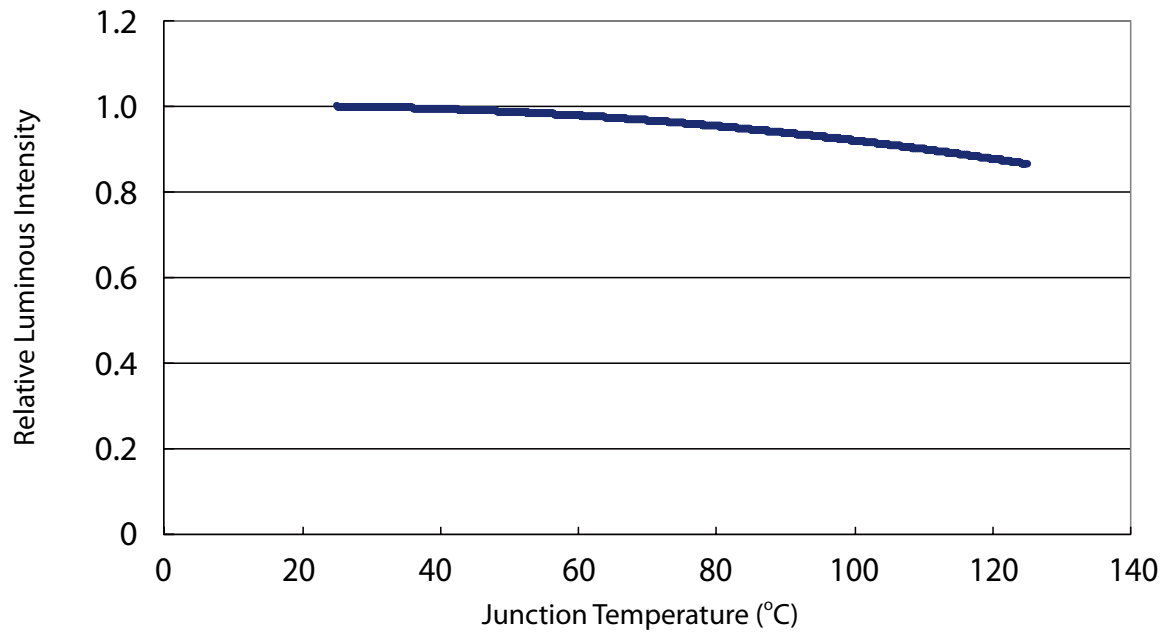

Relative Luminous intensity vs. Junction Temperature (1W Amber)

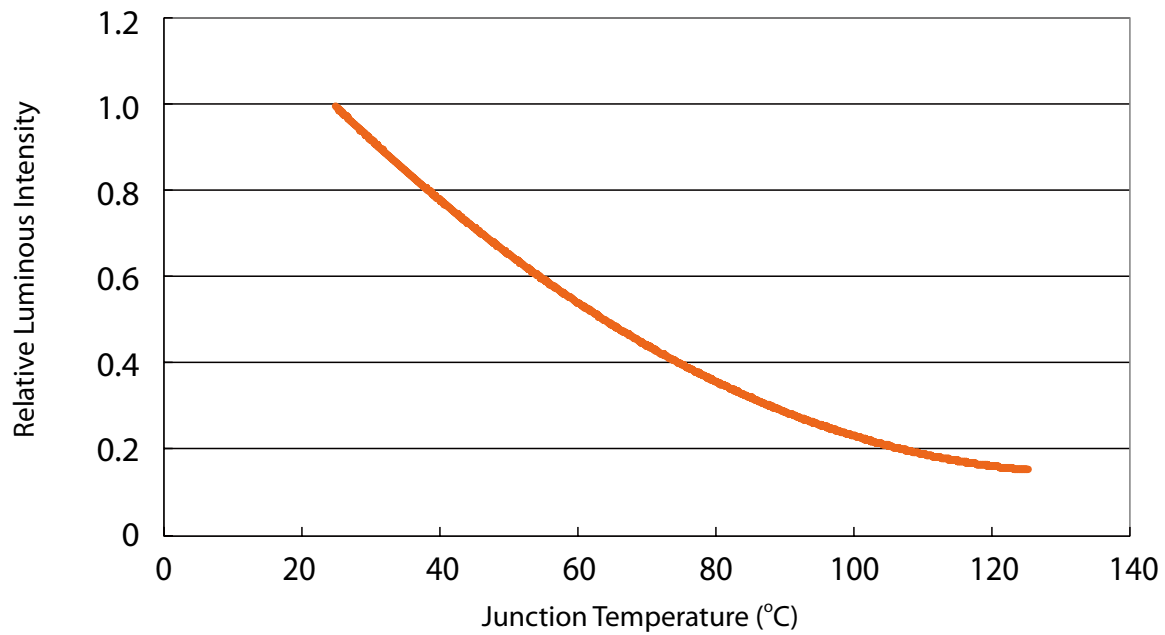

Relative Luminous Intensity vs. Junction Temperature (3W Red)

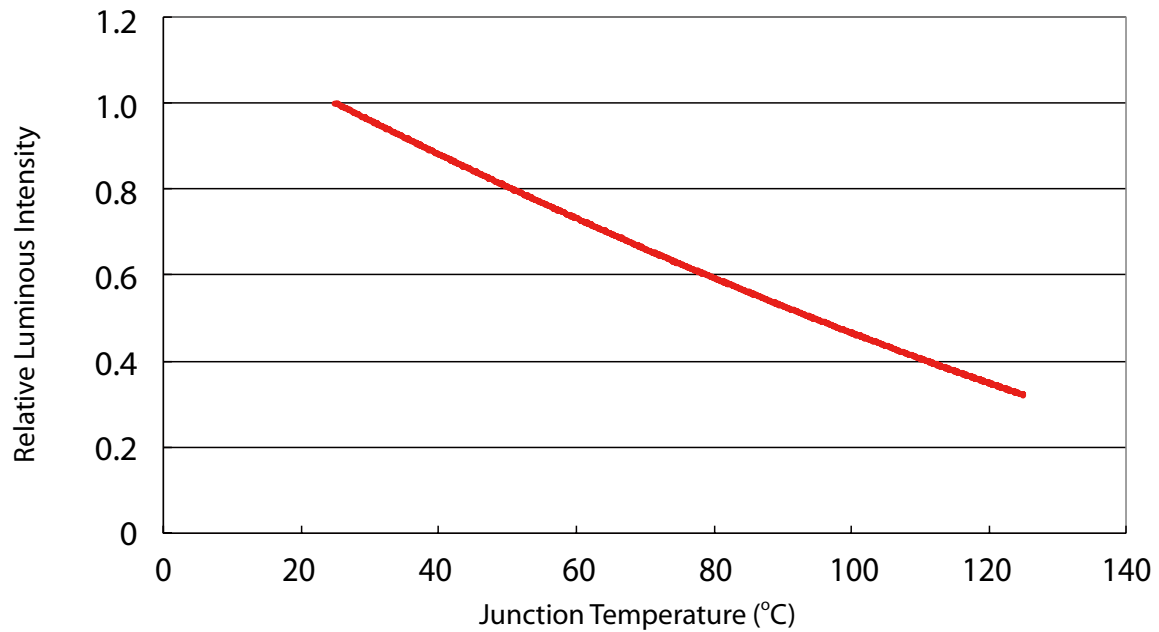

Relative Luminous Intensity vs. Junction Temperature (3W True Green)

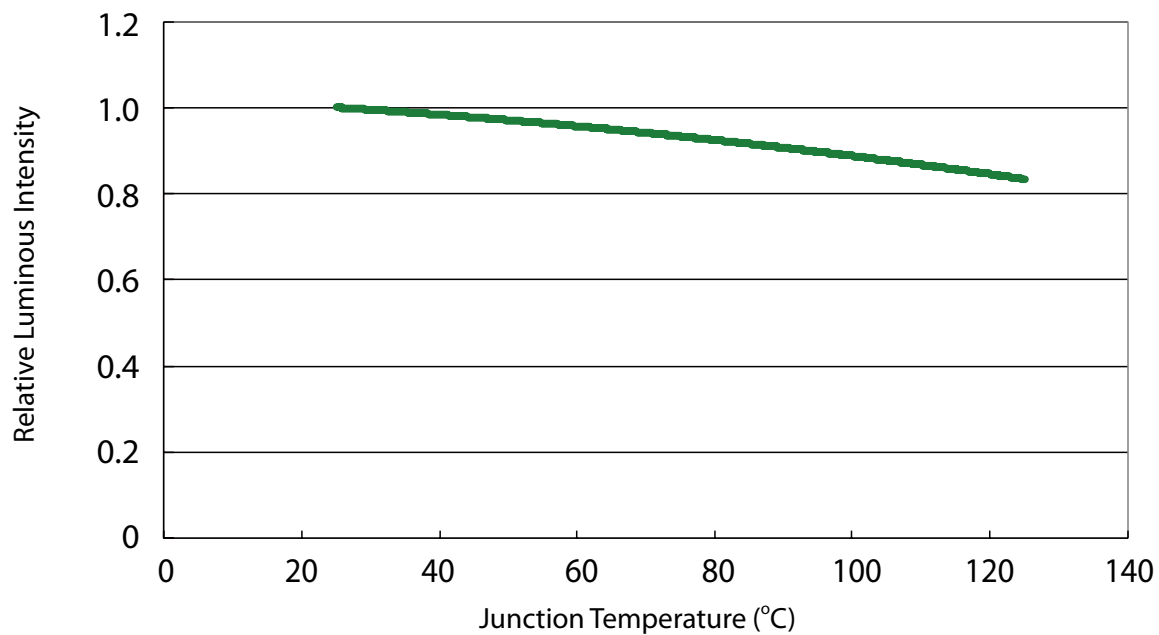

Relative Luminous Intensity vs. Junction Temperature (3W Blue)

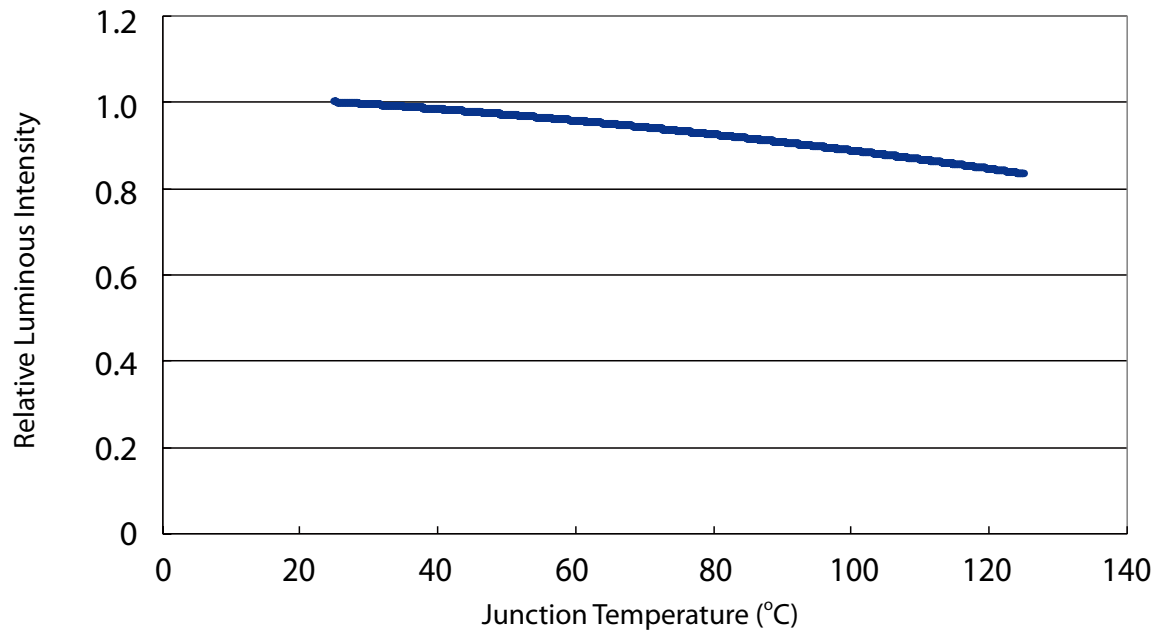

Relative Luminous Intensity vs. Junction Temperature (3W Amber)

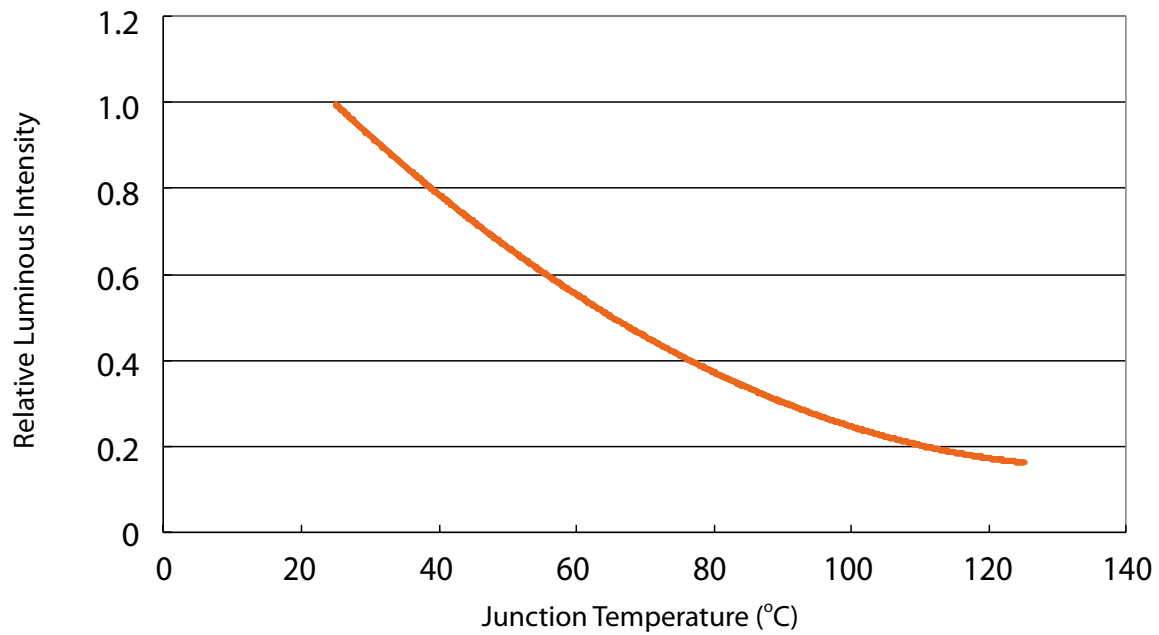

Forward Voltage vs. Junction Temperature (1W Red)

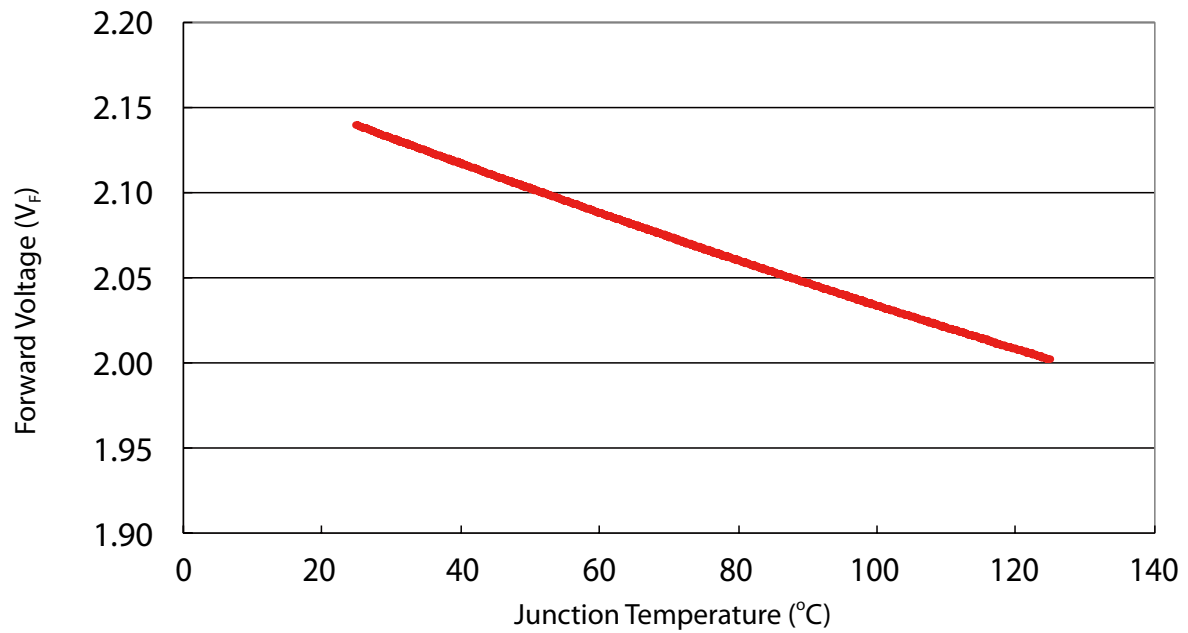

Forward Voltage vs. Junction Temperature (1W True Green)

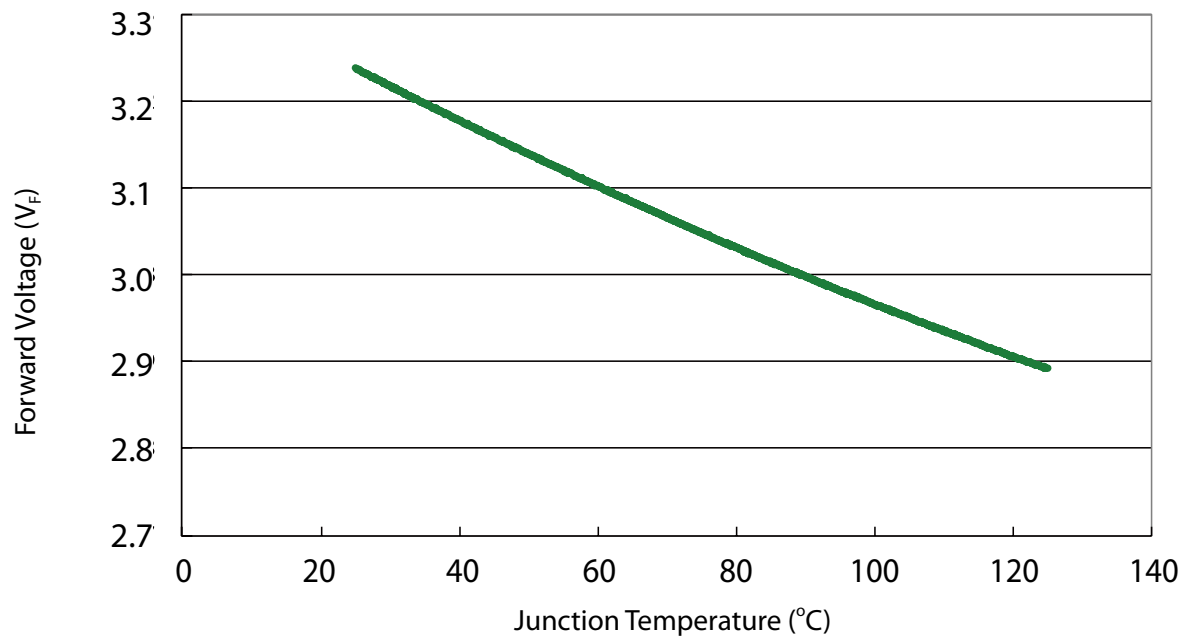

Forward Voltage vs. Junction Temperature (1W Blue)

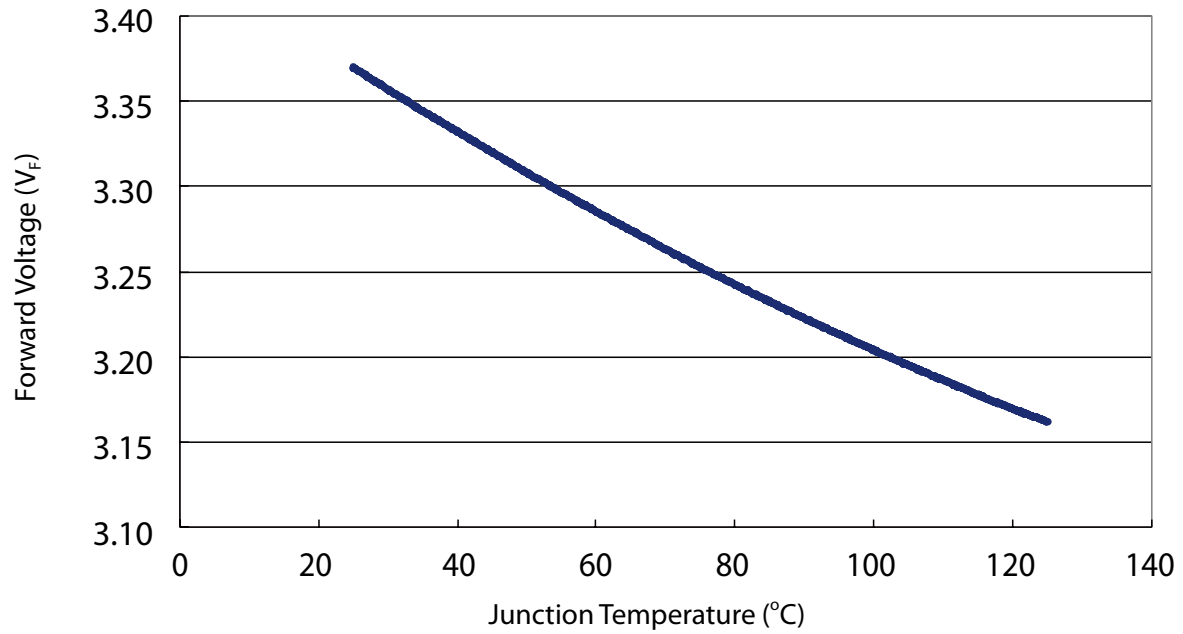

Forward Voltage vs. Junction Temperature (1W Amber)

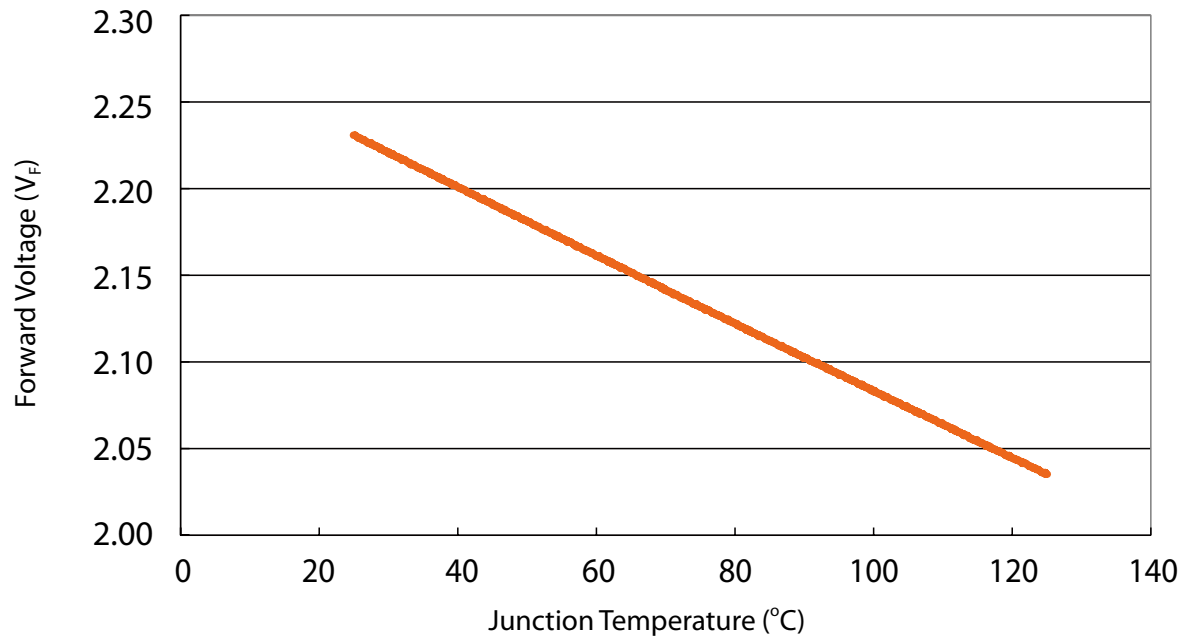

Forward Voltage vs. Junction Temperature (3W Red)

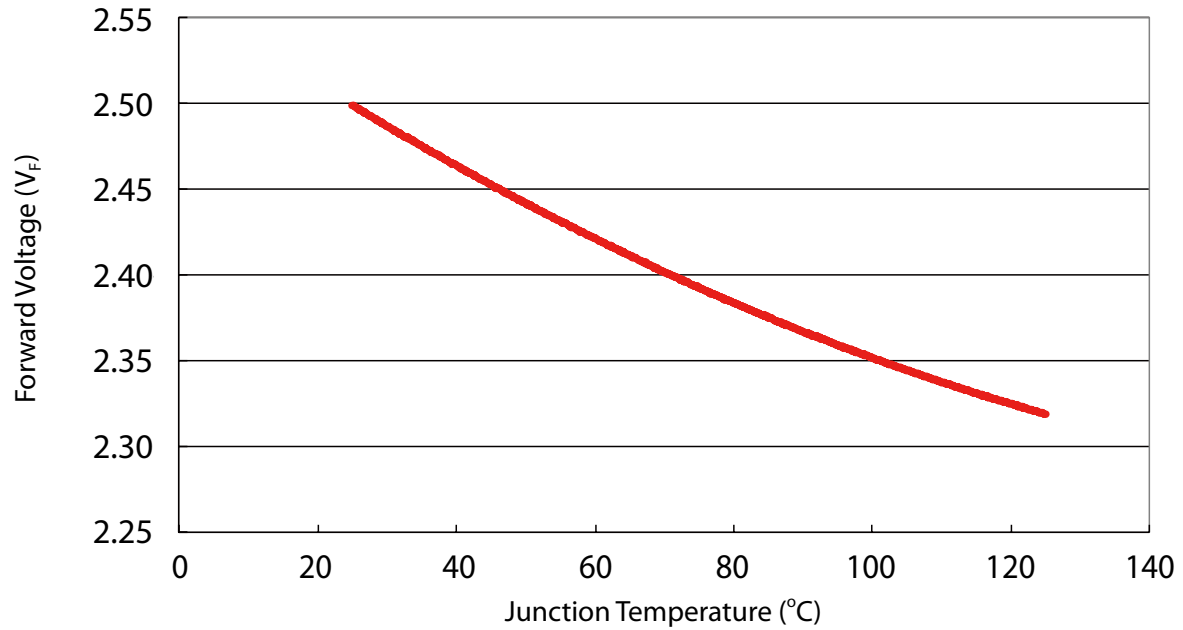

Forward Voltage vs. Junction Temperature (3W True Green)

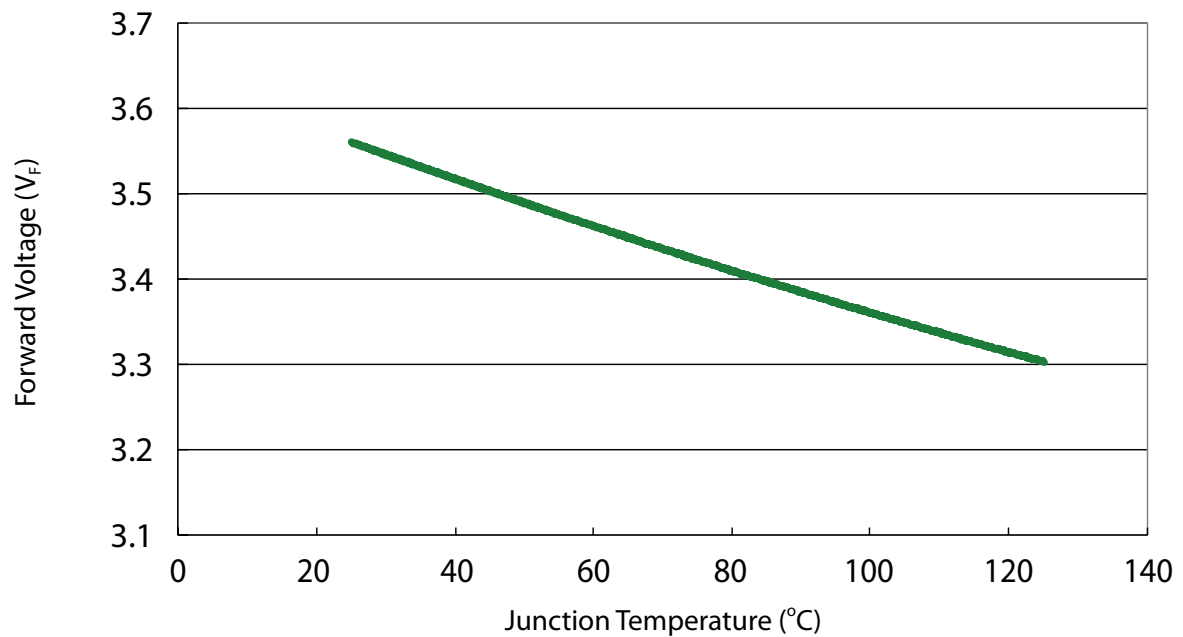

Forward Voltage vs. Junction Temperature (3W Blue)

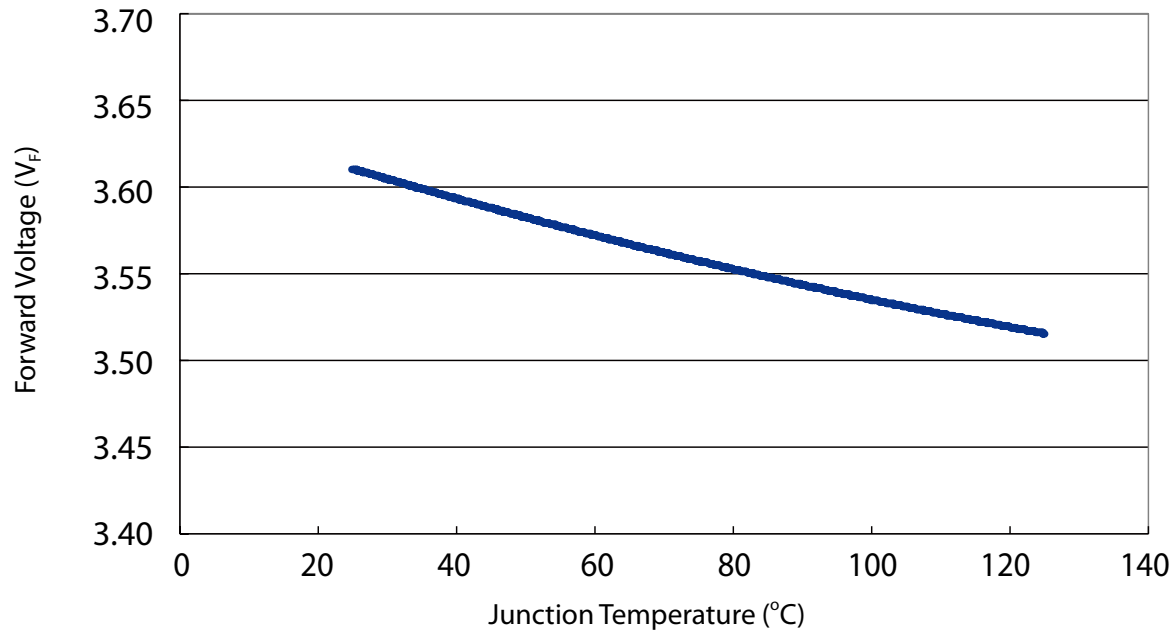

Forward Voltage vs. Junction Temperature (3W Amber)

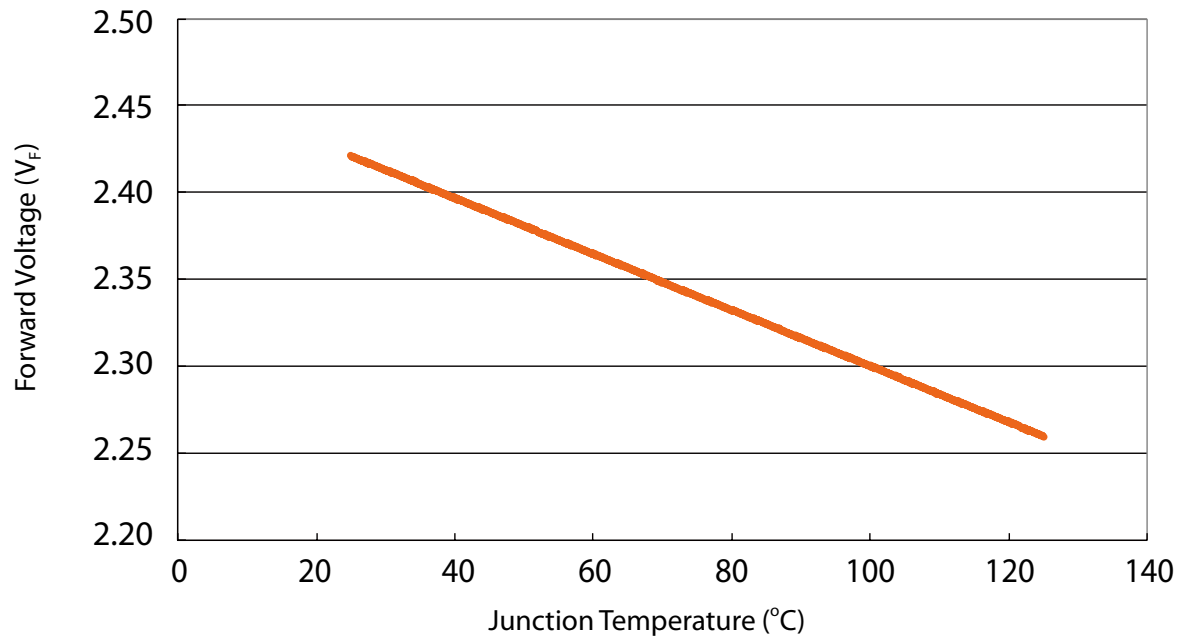

Wavelength vs. Forward Current (1W Red)

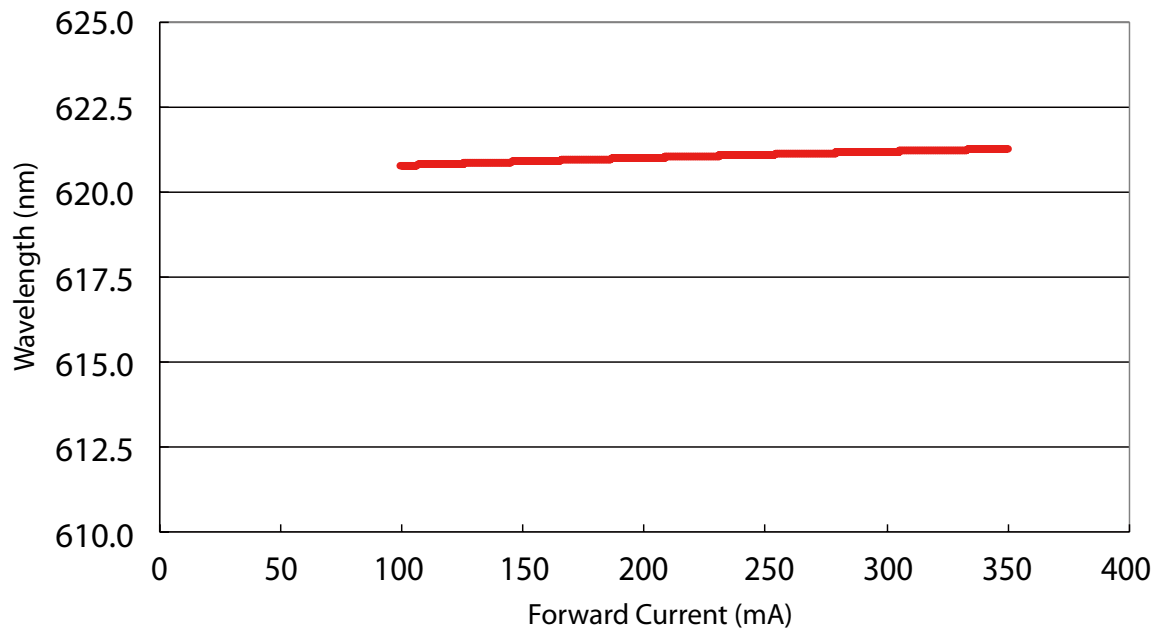

Wavelength vs. Forward Current (1W True Green)

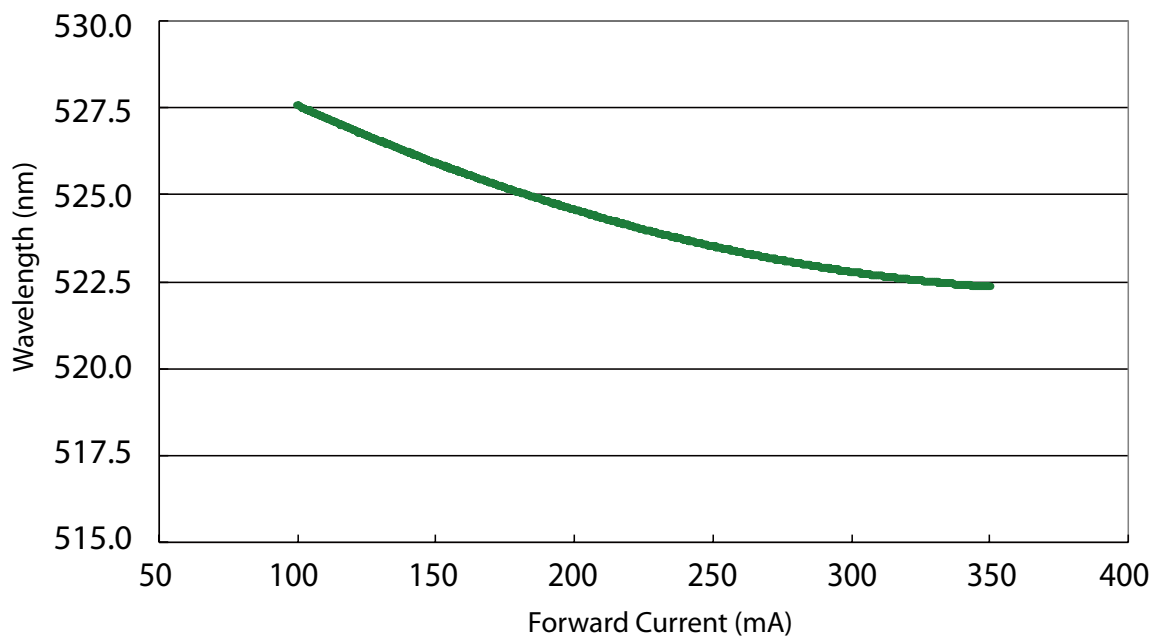

Wavelength vs. Forward Current (1W Blue)

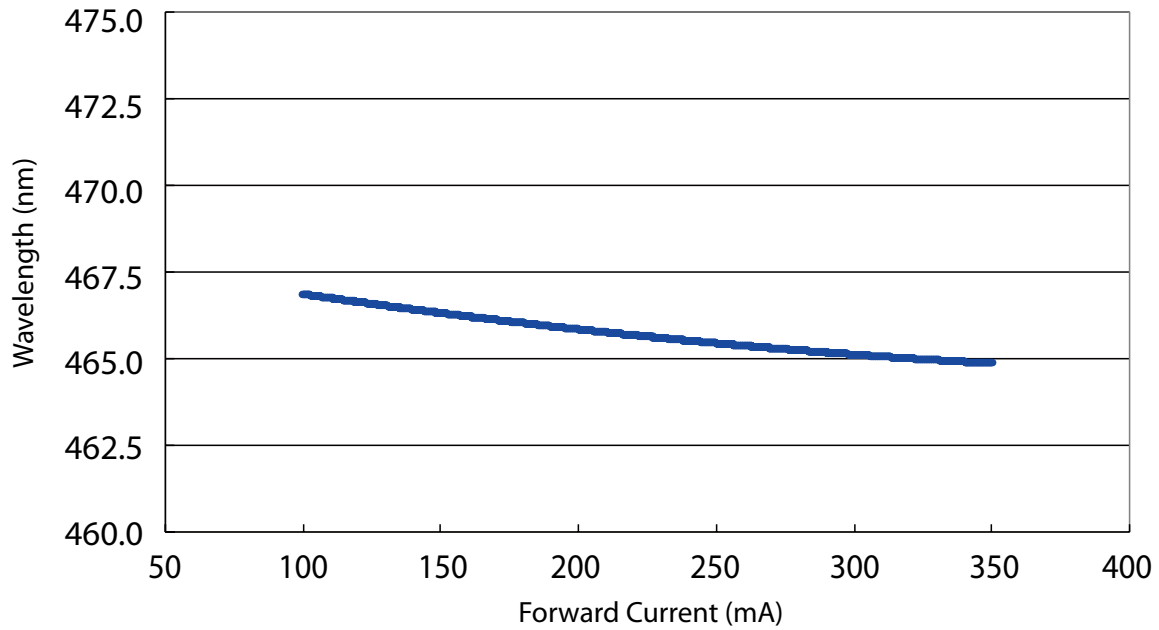

Wavelength vs. Forward Current (1W Amber)

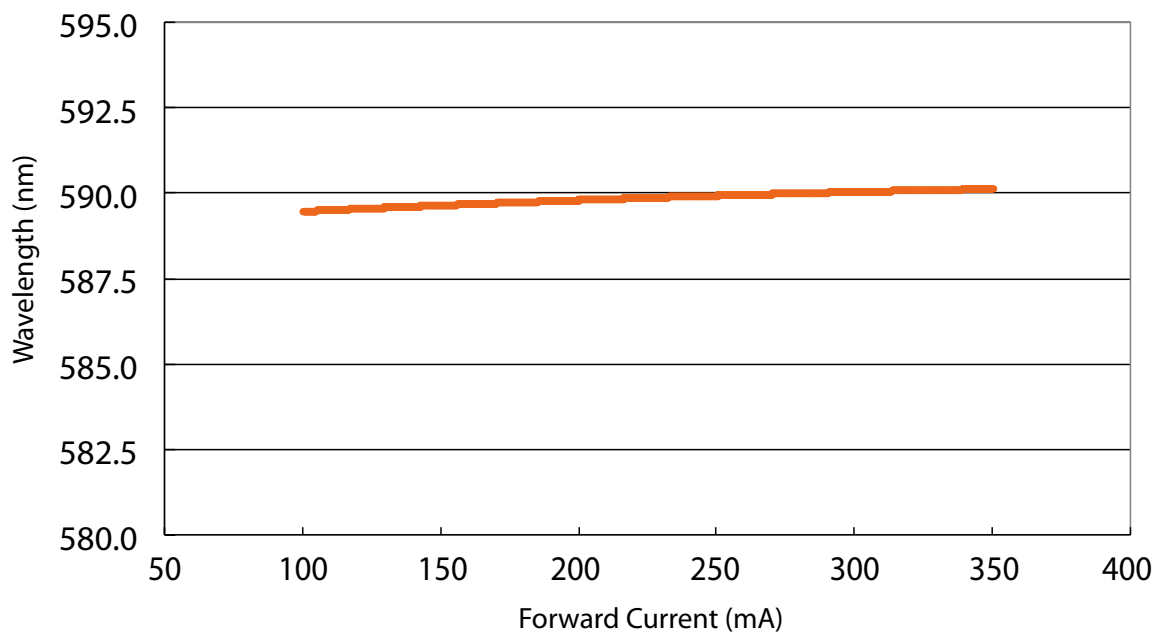

Wavelength vs. Forward Current (3W Red)

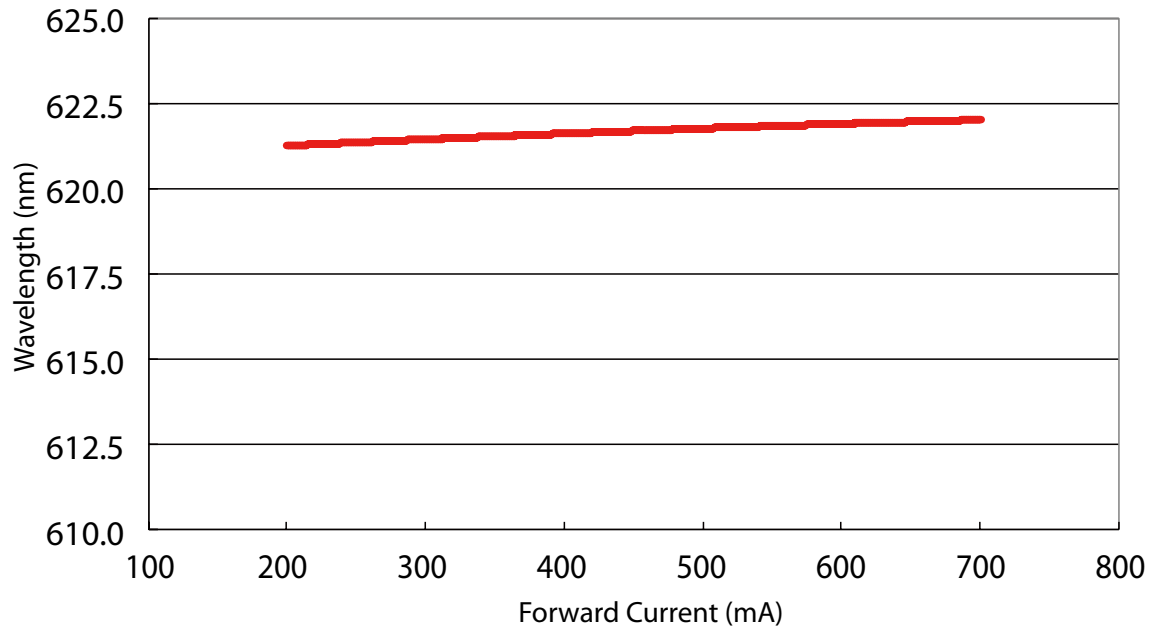

Wavelength vs. Forward Current (3W True Green)

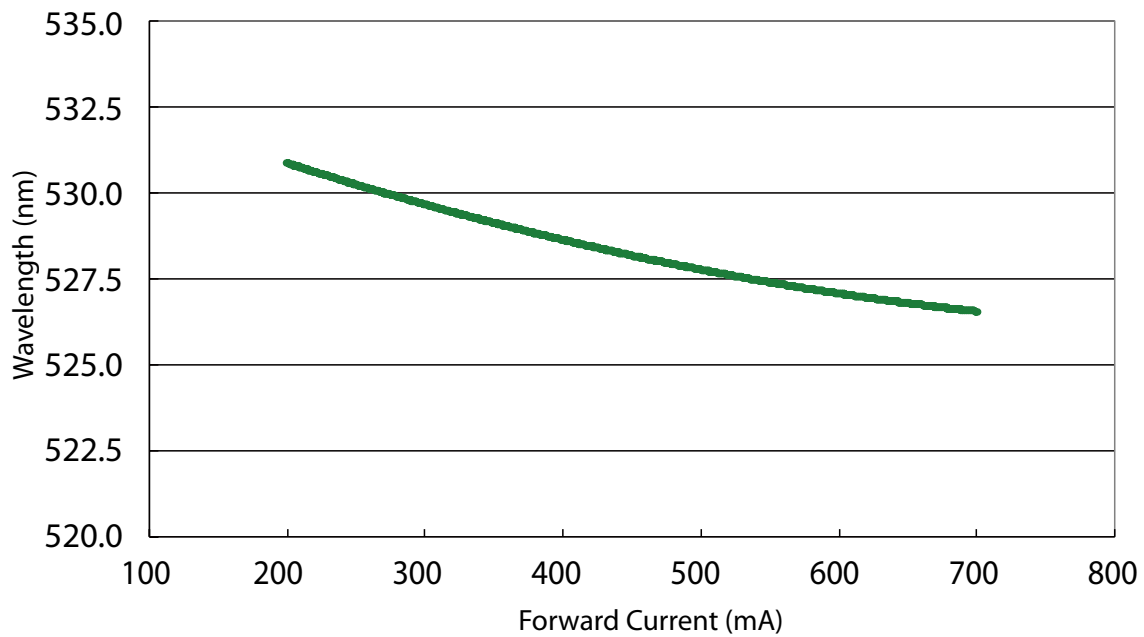

Wavelength vs. Forward Current (3W Blue)

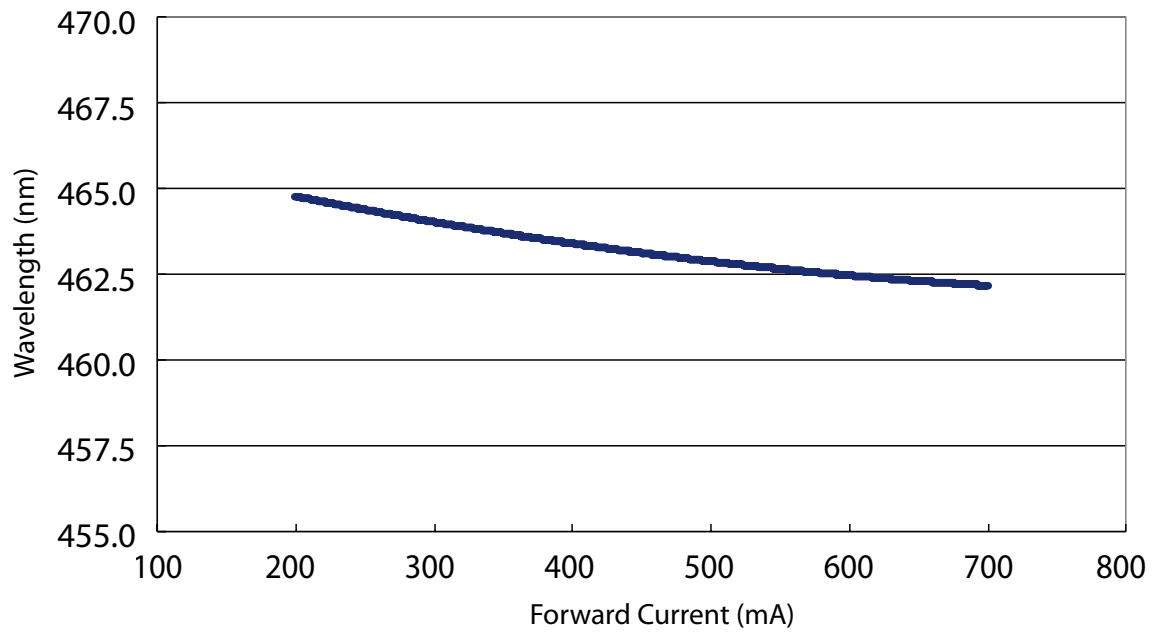

Wavelength vs. Forward Current (3W Amber)

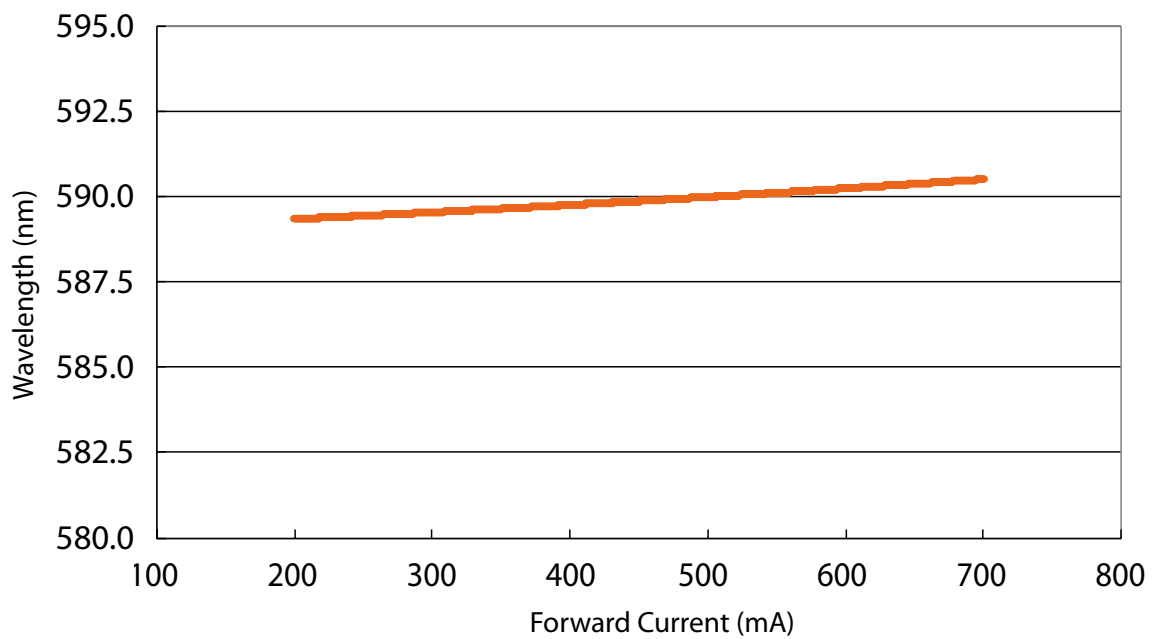

Wavelength vs. Junction Temperature (1W Red)

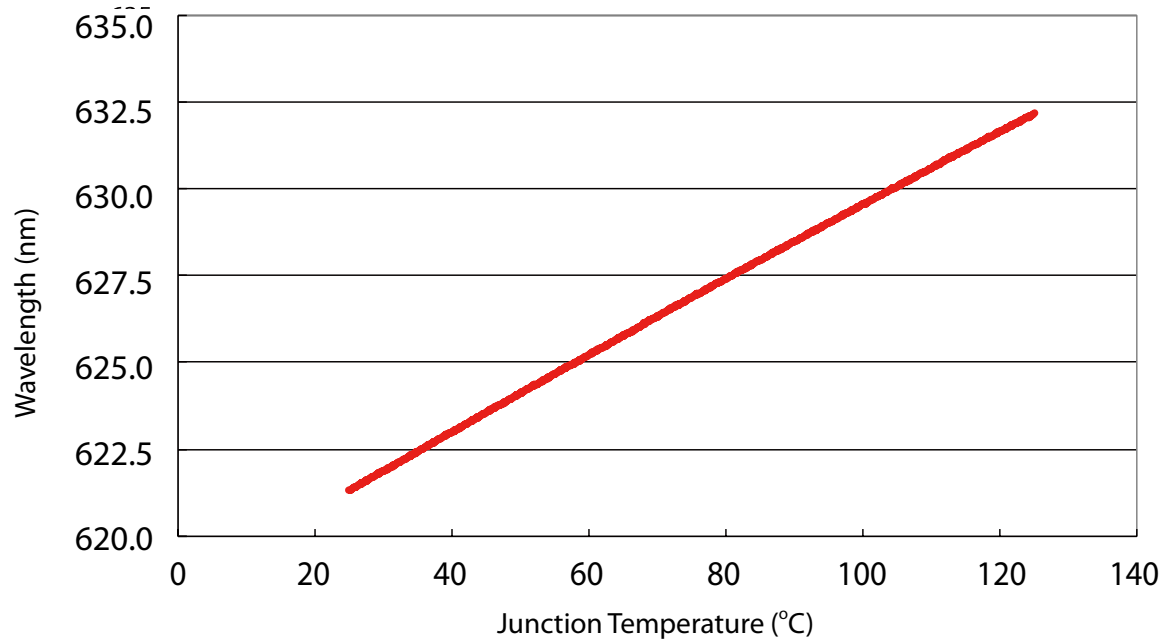

Wavelength vs. Junction Temperature (1W True Green)

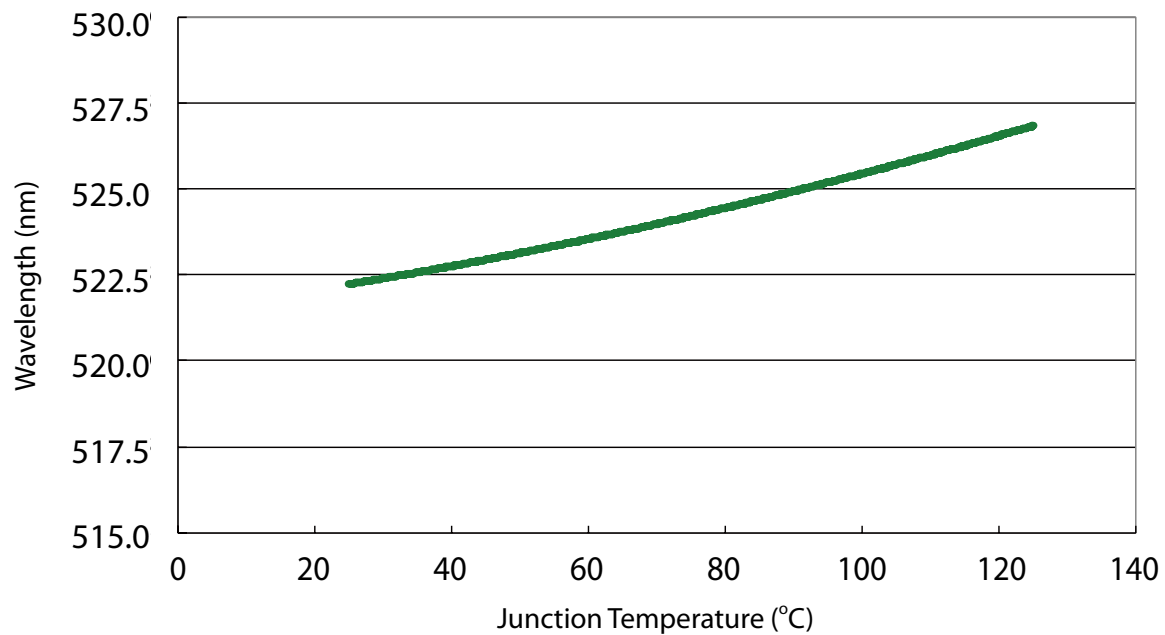

Wavelength vs. Junction Temperature (1W Blue)

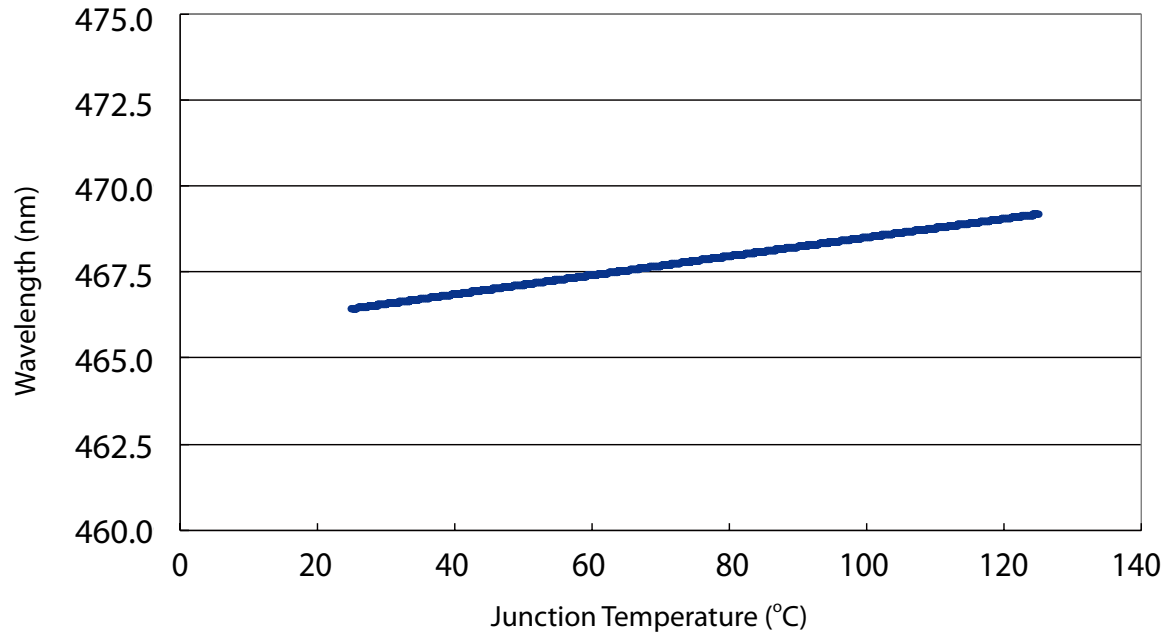

Wavelength vs. Junction Temperature (1W Amber)

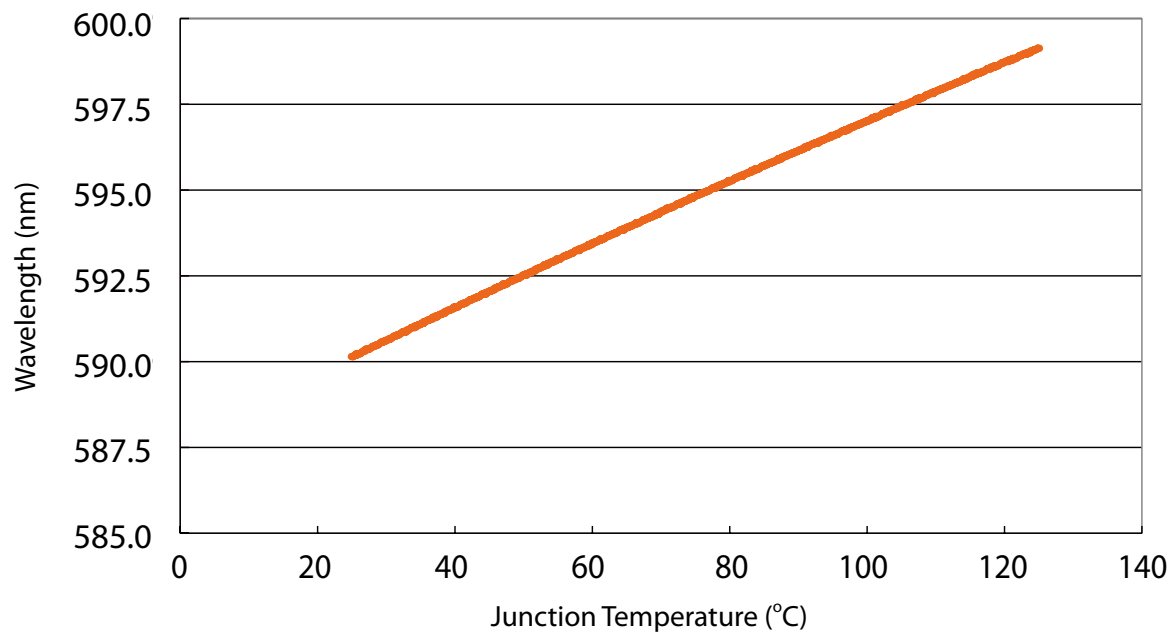

Wavelength vs. Junction Temperature (3W Red)

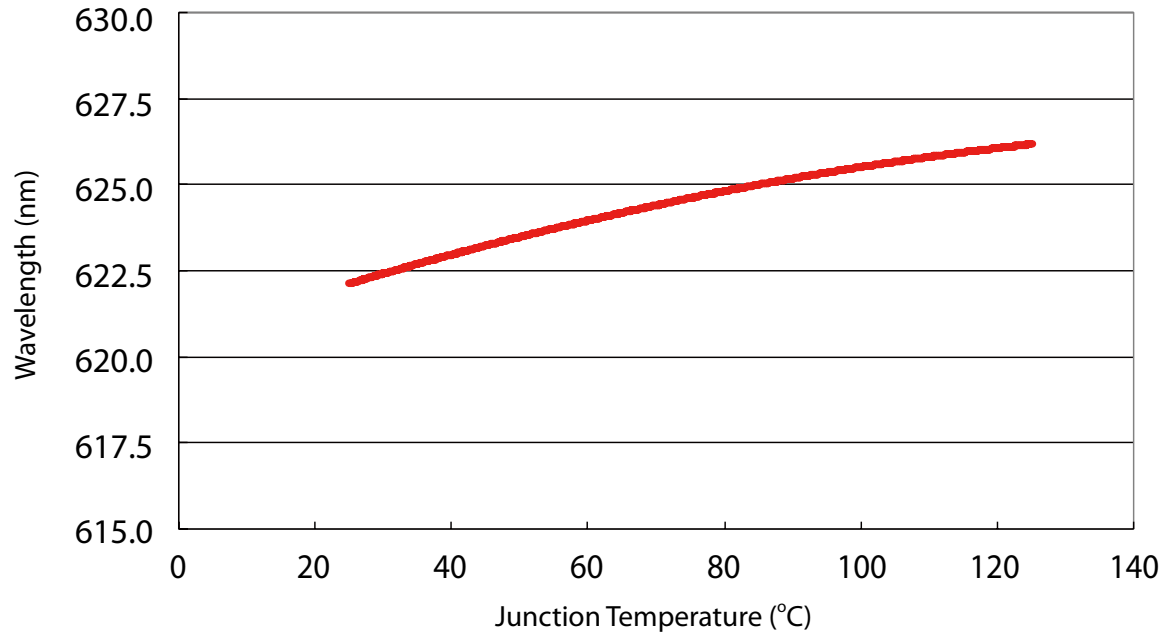

Wavelength vs. Junction Temperature (3W True Green)

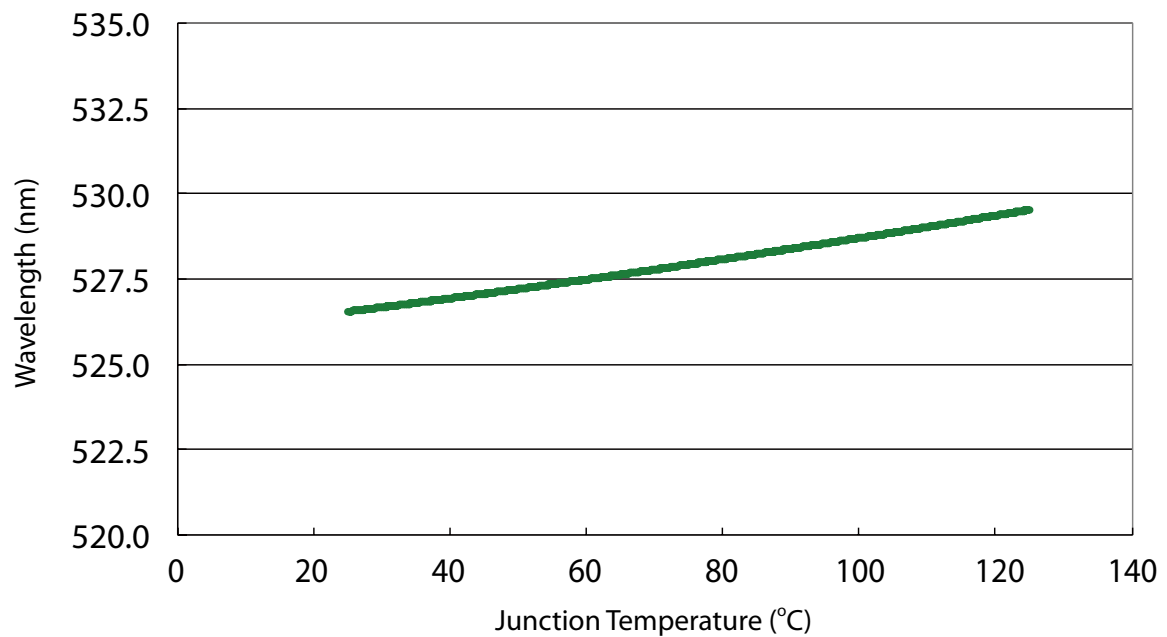

Wavelength vs. Junction Temperature (3W Blue)

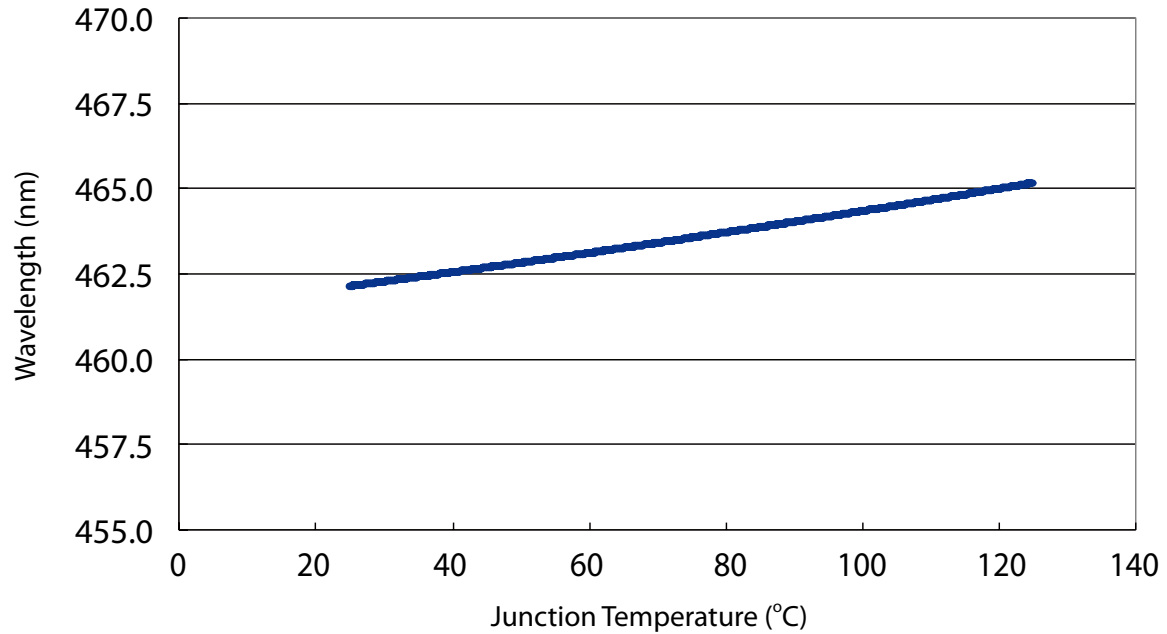

Wavelength vs. Junction Temperature (3W Amber)

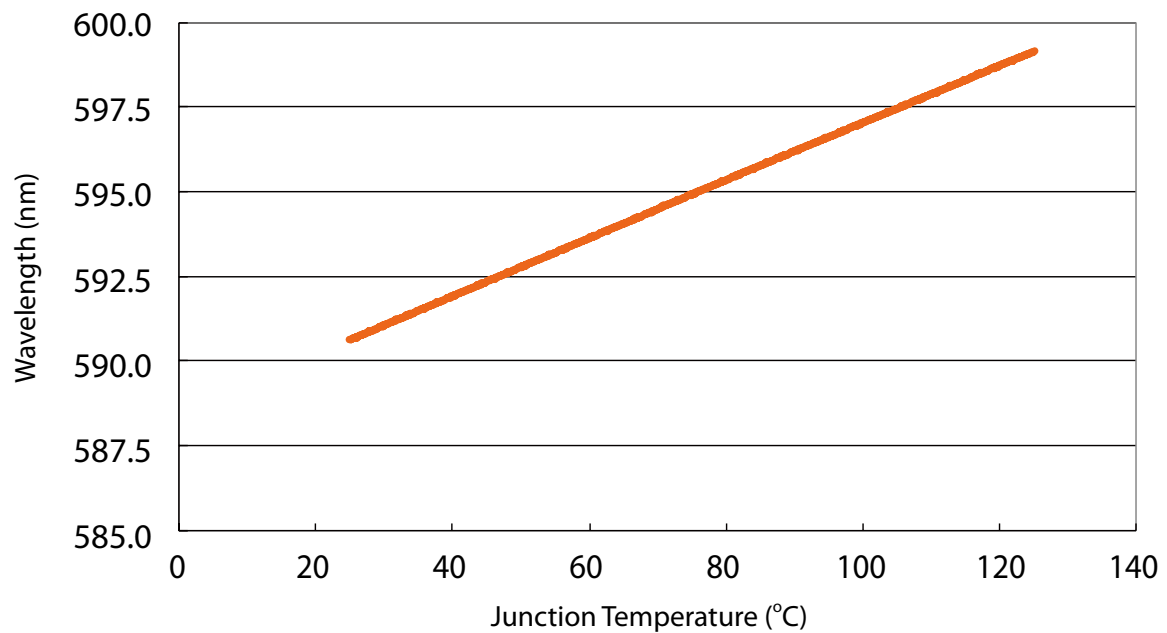

Maximum Current vs. Ambient Temperature (1W Red & Amber)

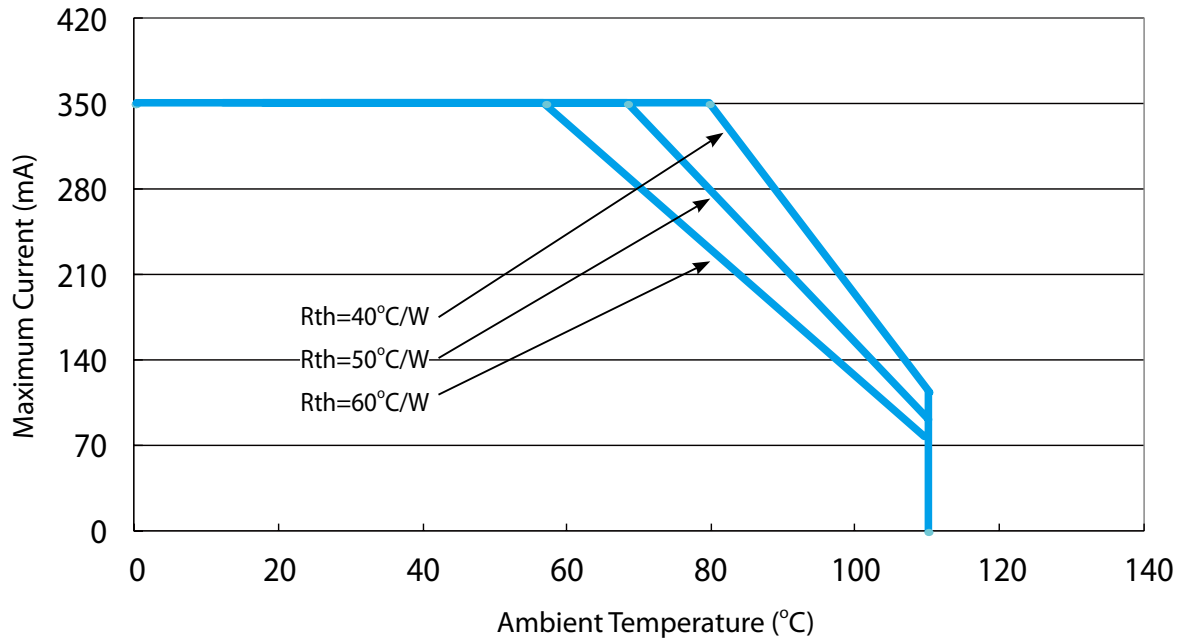

Maximum Current vs. Ambient Temperature (1W Blue & True Green)

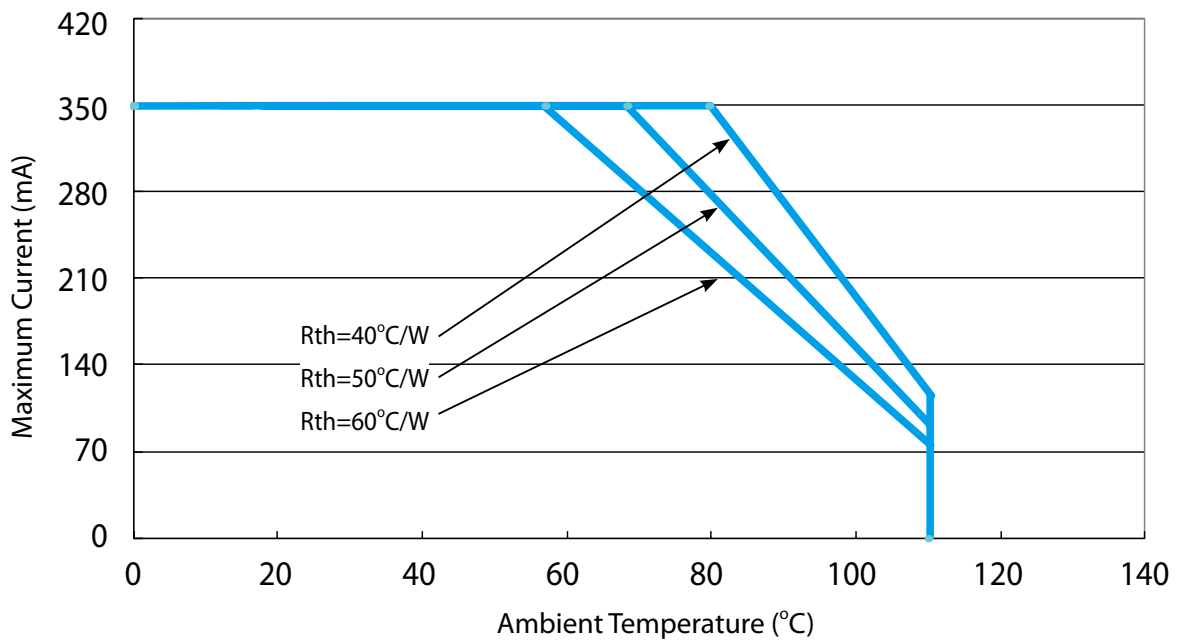

Maximum Current vs. Ambient Temperature (3W Red & Amber)

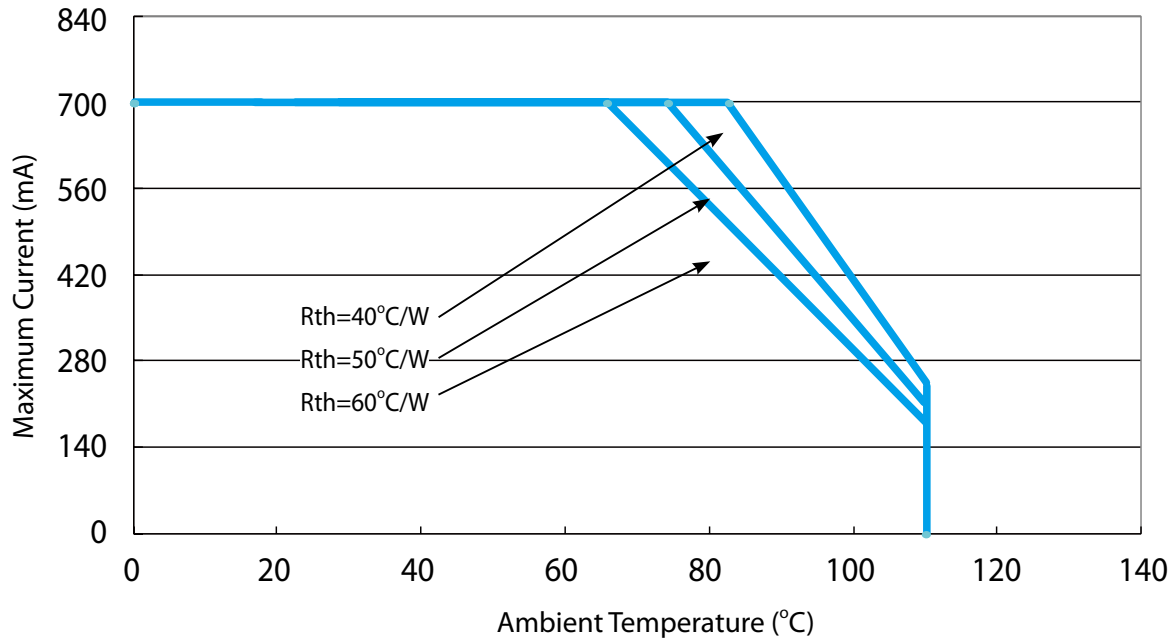

Maximum Current vs. Ambient Temperature (3W Blue & True Green)

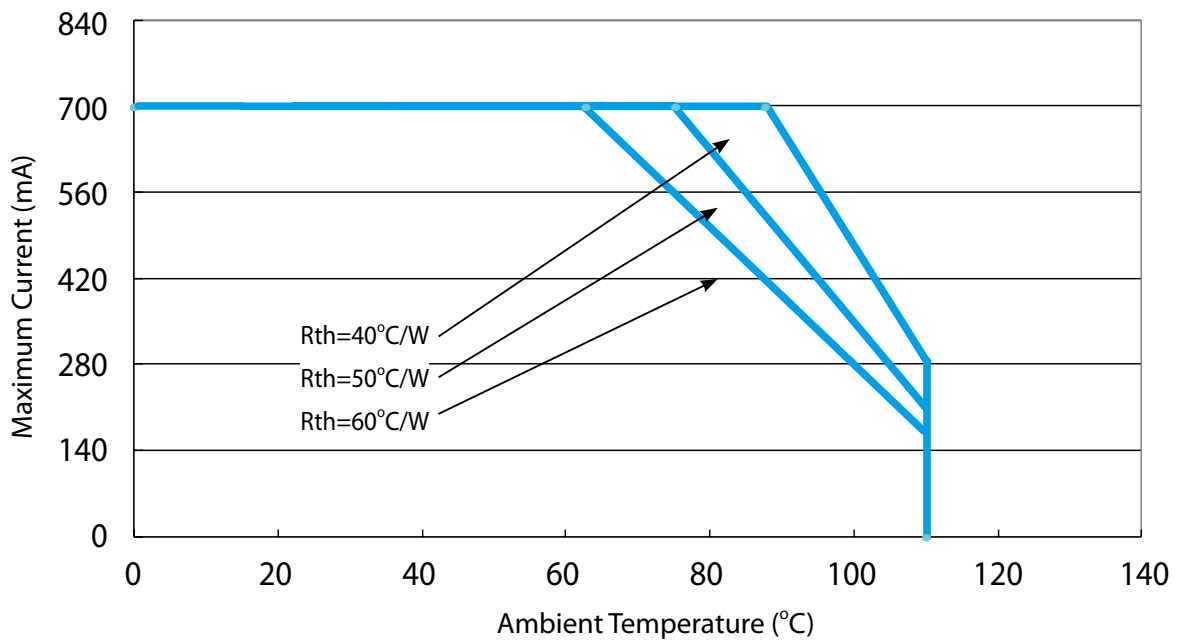

Reflow Profile

The following reflow profile is from IPC/JEDEC J-STD-020D which provided here for reference.

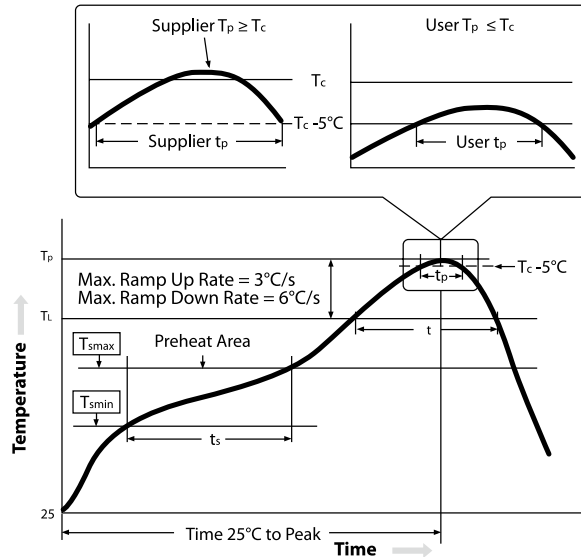

Classification Reflow Profiles

Profile Feature	Low-Temp, Pb-Free Assembl
Preheat/Soak	
Temperature Min (T _{smin})	150° C
Temperature Max (T _{smax})	200° C
Time (ts) from (T _{smin} to T _{smax})	60-120 seconds
Ramp-up rate (TL to T _p)	3° C/ seconds max.
Liquidous temperature (TL)	217° C
Time (tL) maintained above TL	60-150 seconds
Peak package body temperature (T _p) ⁽¹⁾	255° C~260° C
Classification temperature (T _c)	260° C
Time (t _p) within 5° C of the specified classification temperature (T _c) ⁽²⁾	30 seconds
Average ramp-down rate (T _p to T _{smax})	6° C/second max.
Time 25° C to peak temperature	8 minutes max

Notes:

1. Tolerance for peak profile temperature (T_p) is defined as a supplier minimum and a user maximum.
2. Tolerance for time at peak profile temperature (t_p) is defined as a supplier minimum and a user maximum.

Reliability

NO .	Test Item	Test Condition	Remark
1	Temperature Cycle	-40°C~100°C 30, 30, mins	100 Cycle
2	Thermal Shock	-40°C~100°C 15, 15 mins \leq 10 sec	100 Cycle
3	Resistance to Soldering Heat	T _{SOL} =260°C, 30 sec	3 times
4	Moisture Resistance	25°C~65°C 90% RH 24 hrs / 1 cycle	10 Cycle
5	High-Temperature Storage	T _A =100°C	1,000 hrs
6	Humidity Heat Storage	T _A =85°C RH=85%	1,000 hrs
7	Low-Temperature Storage	T _A =-40°C	1,000 hrs
8	Operation Life test	25°C	1,000 hrs
9	High Temperature Operation Life test	85°C	1,000 hrs
10	High Humidity Heat Life Test	85°C, 85%RH	1,000 hrs
11	ON/OFF Test	30 sec ON, 30 sec OFF	1.5W times

Failure Criteria

Item	Criteria for Judgment	
	Min.	Max.
Lumen Maintenance	85%	-
$\Delta u'v'$	-	0.006
Forward Voltage	-	Initial Data x 1.1
Reverse Current	-	10 μ A
Resistance to Soldering Heat	No dead lamps or visual damage	

Cautions

LED avoids being stored and lighted in the environment containing sulfur. Some materials, such as seals, printing ink, enclosure and adhesives, may contain sulfur, avoiding the exposure in acid or halogen environment.

Product Packaging Information

Tape and Reel Dimension

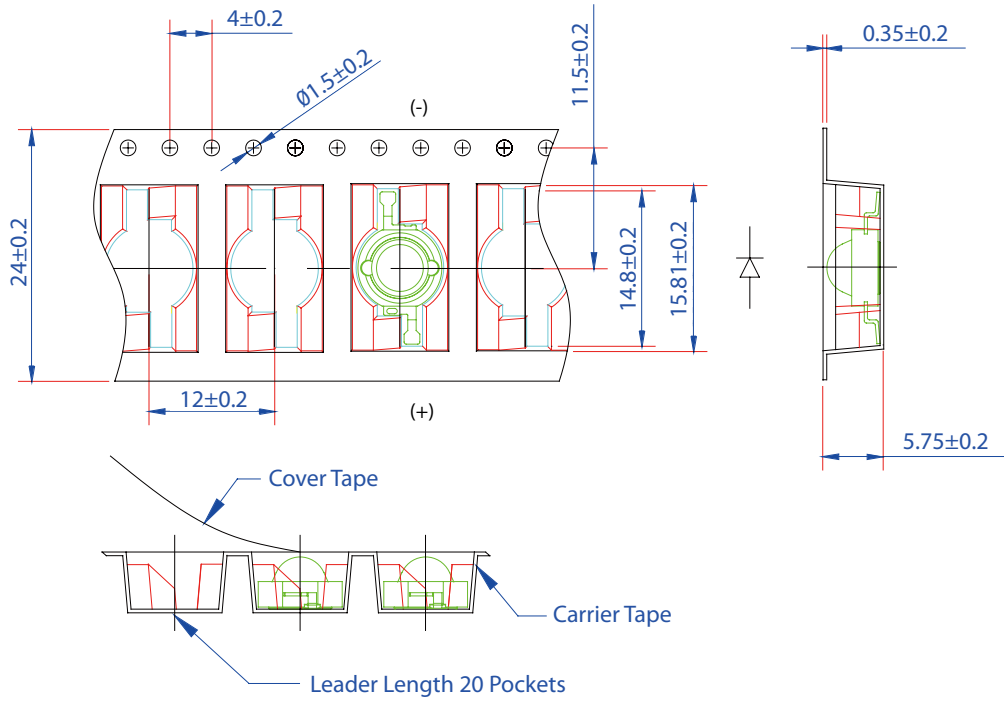

Edixeon Emitter

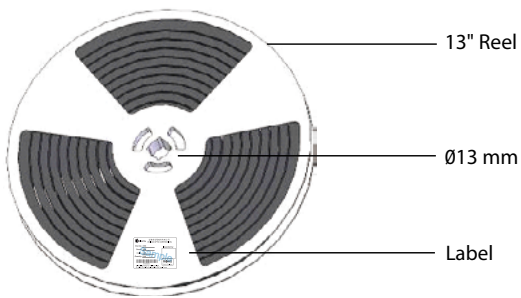

1000pcs LEDs inside

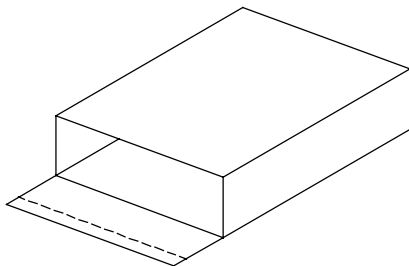
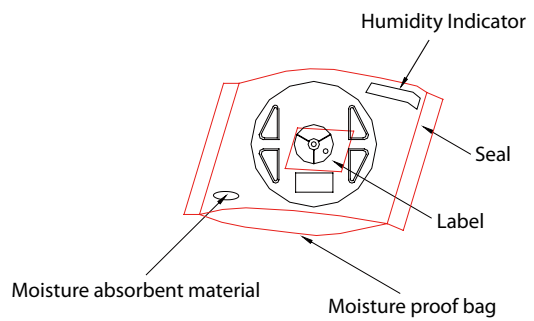

2 bags in 1 box

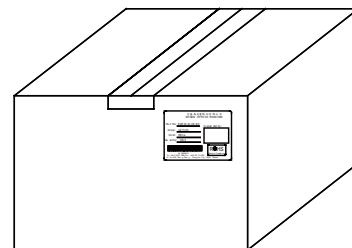

5 boxes in 1 carton

Note : 445*410*415 (Tolerance : ± 5 mm)

Revision History

Versions	Description	Release Date
1	Establish order code information	2014/04/11
2	1. Add True Green color Bin 2. Revise Reliability	2014/09/22
3	1. Revise luminous flux characteristic 2. Update characteristic curve	2014/12/29
4	Add the cautions of reliability	2017/05/26
5	1. Update Product Picture 2. Update Luminous flux characteristic	2017/07/24

About Edison Opto

Edison Opto is a leading manufacturer of high power LED and a solution provider experienced in LDMS. LDMS is an integrated program derived from the four essential technologies in LED lighting applications- Thermal Management, Electrical Scheme, Mechanical Refinement, Optical Optimization, to provide customer with various LED components and modules. More Information about the company and our products can be found at www.edison-opto.com

Copyright©2017 Edison Opto. All rights reserved. No part of publication may be reproduced or transmitted in any form or by any means, electronic or mechanical, including photo copy, recording or any other information storage and retrieval system, without prior permission in writing from the publisher. The information in this publication are subject to change without notice.

www.edison-opto.com

For general assistance please contact:
service@edison-opto.com.tw

For technical assistance please contact:
LED.Detective@edison-opto.com.tw