

PrimeFilm 7250 Plus User's Manual



FEDERAL COMMUNICATIONS COMMISSION (FCC) STATEMENT

This Equipment has been tested and found to comply with the limits for a class B digital device, pursuant to Part 15 of the FCC rules. These limits are designed to provide reasonable protection against harmful interference in a residential installation. This equipment generates uses and can radiate radio frequency energy and, if not installed and used in accordance with the instructions, may cause harmful interference to radio communications. However, there is no guarantee that interference will not occur in a particular installation. If this equipment does cause harmful interference to radio or television reception, which can be determined by turning the equipment off and on, the user is encouraged to try to correct the interference by one or more of the following measures:

- Re-orient or relocate the receiving antenna.
- Increase the separation between the equipment and receiver.
- Connect the equipment into an outlet on a circuit different from which the receiver is connected to.
- Consult the dealer or an experienced radio/TV technician for help.

Warning :

Use only shielded signal cables to connect I/O devices to this equipment.

You are cautioned that changes or modifications not expressly approved by the party responsible for compliance could void your authority to operate the equipment.

TABLE OF CONTENTS

Getting Started	4
Quick Installation Guide (QIG)	6
Installing Software and Driver	6
Installing Hardware	7
Inserting 35mm Slides	8
Inserting 35mm Filmstrips	9
One Button Scan (PC ONLY Feature)	9
How to Scan Film and Slides	10
STEP 1 - Acquire Driver	10
STEP 2 - Select Film Type	10
STEP 3 - Optional Prescan	10
STEP 4 - Set Scan Parameters	11
STEP 5 - Set Scan Preferences	12
STEP 5 - Scan Setting Reference	13
STEP 6 – Scan	16
User Interface	17
I Main Window Area	18
II Preview Window Area	22
III Active Frame Setting Area	26
IV Thumbnail Panel Area	27
Basic Quick Scanning , Troubleshooting & Tips	28
Technical Support	36

GETTING STARTED

Check the package content before getting started.

For Quick Installation please refer to Quick Installation Guide. (Ref. Pg. 06)

Important! Save the original box, receipt, and packing material for future shipping needs.

Package Contents:

- Film Scanner
- Wall-Mount Adapter

Warning Using any other power adapter may severely damage the scanner and will void the product warranty.

- USB 2.0 Cable.
- Quick Installation Guide

GENERAL GUIDANCE:

- Only use the supplied USB cable. Connect the computer to the scanner directly using the USB 2.0 cable.
- **For systems using USB 3.0 (USB-C and USB mini port), a Hub may be required please see [Connectivity issues with my new scanner](#)**
- **If your situation requires a longer USB cable, use only cables 6ft or less in length, do not use a cable extender**

Also for the best connectivity on Desktop computers use only the rear USB ports

- If there are any other devices (multifunction devices, i.e. printers, scanners, web- cam) connected to the computer through USB you may need to disconnect them, this does not apply to Wi-Fi connected devices
- A minimum of 4 GB RAM (Windows/Mac) is required, 8GB or more highly recommended.

Operating Ambient Temperature Range
50° to 104°F (10° to 40°C)

Note: Do not turn on the scanner unless it is within this range. If the scanner has been stored or transported outside of this range, allow it to return to within this range before turning it on.

Operating Ambient Humidity Range 15% to 76% relative humidity
(non-condensing)

Note: If the scanner is stored or to be transported in cold temperature and then brought into a warm / humid environment condensation may occur.

QUICK INSTALLATION GUIDE

INSTALLING SOFTWARE AND DRIVER

Installing Scanner Driver

NOTE: Make sure the scanner is NOT connected to the computer during the CyberView X driver installation.

- a. Download the CyberView X scanning software from the website [Download Drivers Click Here](#)

PC – 1. Open the download location Double click the "CyberView" icon  to open the zipped file
2. Click on the CyberView X_Windows installer  to begin the installation, follow the onscreen prompts

MAC – Download the driver from the above link, then click on the CyberViewX_Mac file in the downloads folder this will create a CyberView removable drive icon on the desktop, Open your Applications folder next open the CyberView drive and drag the CyberView icon into the Applications folder to install it.

NOTE: Apple systems may display a warning that the software was from unidentified developer because it was not downloaded from the Apple Store, once you run the installer, if you see this warning, next click on the Apple icon – System Preferences – Security & Privacy – Look for the message CyberView attempted to run, Select Open Anyways



Please Note: When installing your new scanner onto a Windows system that already has another **USB** Scanning device **CONNECTED**

EXAMPLE: Flatbed scanner or All-in-one Scan/Copier/Printer device, it may be necessary to power off, or if there is no on/off switch disconnect the other scanner from the USB port for the Film scanner to work properly, this does not apply if the device connect via WiFi

Installing Hardware a. Connect the slide scanner to a power source.

1. Locate the power switch on the lower left side back of the scanner. Make sure the scanner is

TURNED



2. Plug the AC adapter into an AC power source FIRST before plugging it into the scanner.

3. Attach the USB cable to the computer using the standard USB adapter end. Attach the U shaped USB adapter end of the cable to back panel of the scanner.

1. Lid
2. Slide Holder
3. Film Deck
4. One Button Scan
5. Release Switch
6. Viewing Window

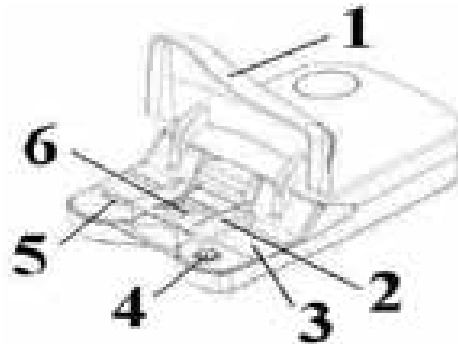

Attention Before Scanning... Make sure there is no filmstrip inside scanner before you insert the slide and there is no slide inside scanner before you insert the filmstrip.

Please note the slide and filmstrip cannot be put into the scanner at the same time.

Mounted Slides

1. Open scanner lid
2. Release the slide/film holder (5) put in slide “shiny side up” then close the slide holder.
3. Close scanner lid
4. Ready to scan

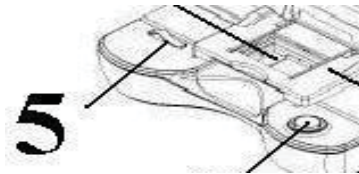

5. Set Scan settings and preferences See Page 13

Note: Some slide mounts are thin and may require you to apply gentle pressure to the edge of the mount after insertion for it to register in the scanner, you will know it is detected by the Preview bar in the user interface, the icons will illuminate in color

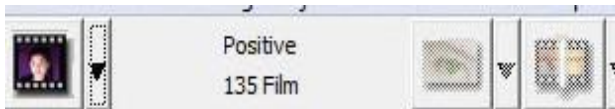

No Slide detected
(tool bar greyed out)



Slide is detected

Filmstrips

1. Open the scanner lid
2. Release the slide holder
3. Position the film that you like to scan in the center of the viewing window (6)
4. Push down the frame and close the slide holder
5. Close the scanner lid
6. Ready to scan

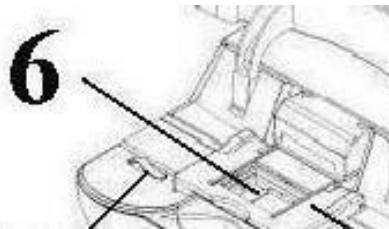

One Button Scan (PC ONLY)

1. FIRST you must Open the CyberView software (see page 10 to acquire the CyberView driver program)
2. Configure Scan Settings (see Page 13)
3. Select the Scan to directory, file format (TIF or JPG, once configured, Press the scanner button) to begin scanning.

NOTE: If you do not open CyberView FIRST, the scan button will not function.

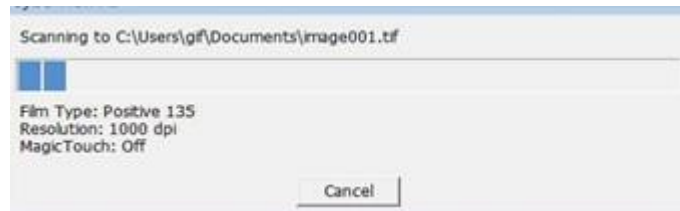

HOW TO SCAN

STEP 1 – Turn on the scanner Wait for the flashing light to come on steady indicating the hardware is ready to use.

Acquire Driver

(For PC User) Open CyberView from Start – All Programs –CyberView or desktc

(For MAC User)

Open Macintosh Hard drive – Applications –CyberView X.app or from the Apple menu Go – Applications – CyberView X.app



STEP 2 – Select Film Type

Select the film type to be scanned – Positive , Negative or B&W (Black and White).



STEP 3 – Optional Prescan (To be used if you wish to pre-edit the images before final scan

Select the “Prescan Current Frame“ to Prescan the slide currently loaded into the scanner or “Prescan All.“ to Prescan an entire negative strip

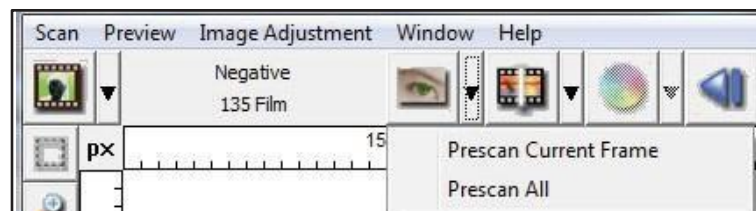

HOW TO SCAN...cont.

STEP 4 – Set Scan Parameters

Notice: Higher scanning resolutions result in greater scanning time and hard disk space requirements.

a. Resolution

The default scanning resolution is 1000dpi, additional resolution options are listed below.

b. Color Depth

Choose between 8 and 16bit. A higher color depth setting will result in a larger range of colors in the final scanned image.

The Film Scanner color depth is 48 bit true color. The scanning software has the capability of selecting 8 bit color mode or 16 bit color mode when scanning, This will produce 24 or 48 bit color images, 8 bits or 16 bits per Red, Green and Blue color channels.

Example:

8 bit mode = 8 Red, 8 Green, and 8 Blue for a total of 24 bit color

16 bit mode = 16 Red, 16 Green, and 16 Blue for a total of 48 bit color”

Scan Mode –Fast, Normal mode produces a scan in JPEG format while Quality produces a non-compressed, “loss-less” TIFF image.

Scanning Resolution	Color Depth (by RGB channel)	Color Mode	File Size TIFF (no compression)
300dpi	8 bit	24-bit	~350Kb
600dpi	8 bit	24-bit	~1MB
1800dpi	8 bit	24-bit	~12MB
3600dpi	8 bit	24-bit	~52MB
7200dpi	8 bit	48-bit	~208MB

Set Scan Preferences

Select Scan - Preference - Film Type - Scan Setting or click the Settings icon on the main user interface

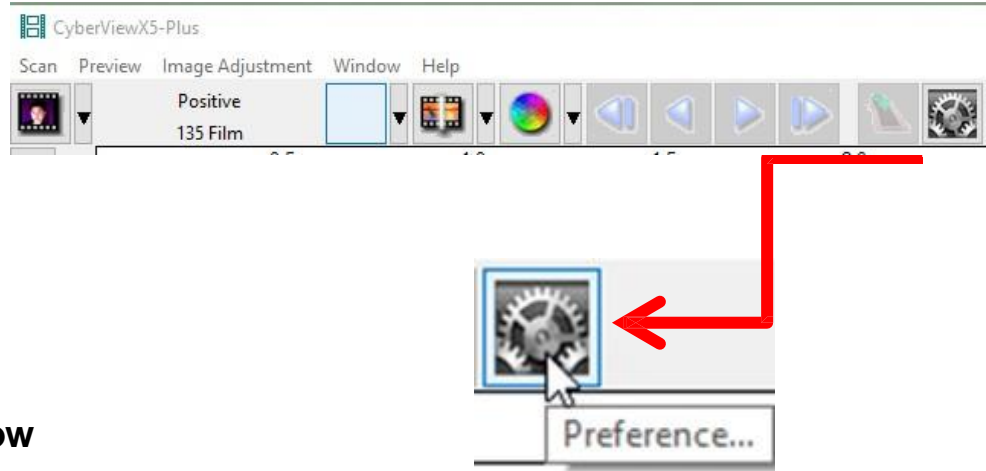
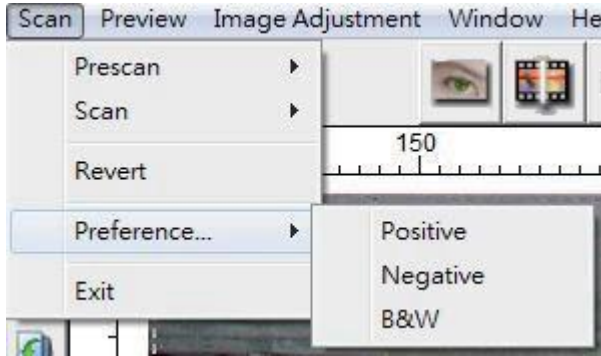

This opens the main settings window

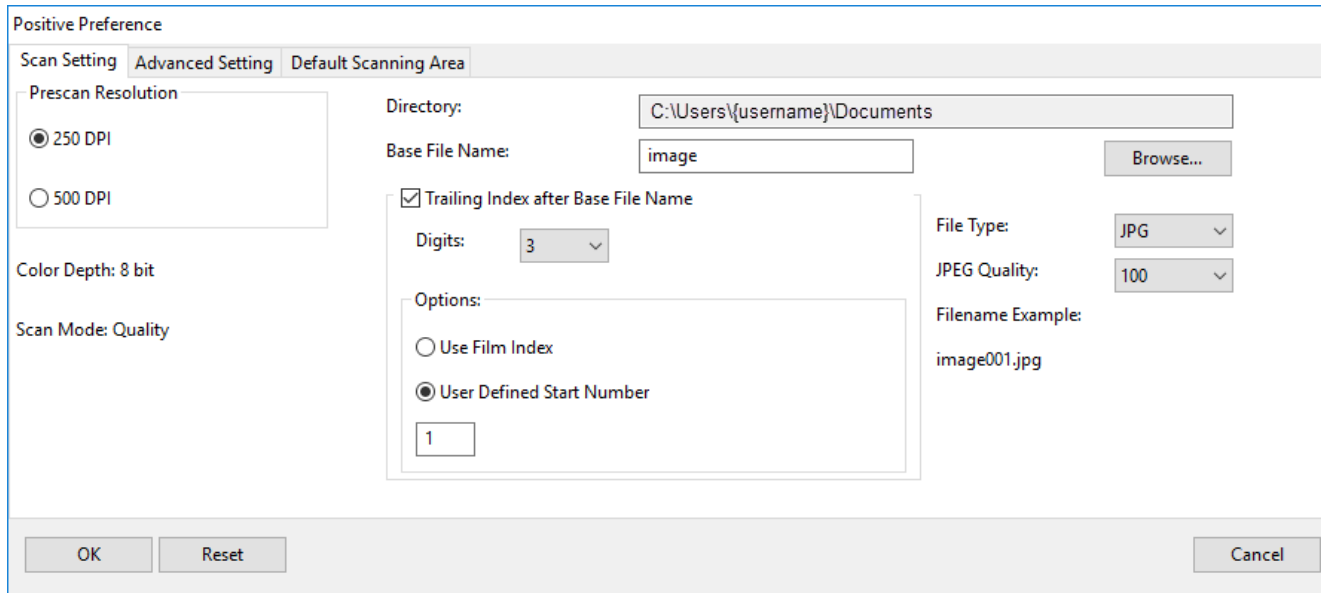

Scan Setting Reference

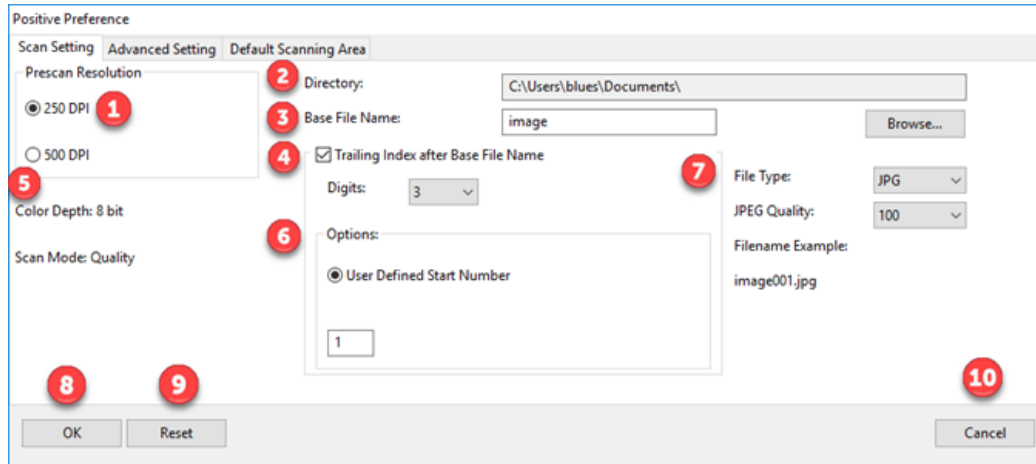

- 1 Prescan Resolution:** use this when prescanning only, the 500 dpi setting produces a larger prescan view when in full screen mode
- 2 Directory:** Select where the files are saved to, Documents is the default setting, to change select Browse and choose a different location
- 3 Base File Name:** This is the file name applied to every image which will then have a number after it, image is the default
- 4 Trailing Index after Base File Name:** This is the number length, digits 3 default file name example image001, you can select 1-6 digits for the number length
- 5 Color Depth:** These can be configured in the Active Frame settings window 8 bit is 8 bits per RGB channel = 24 bit color mode, 16 bit is 16 bits per color channel = 48 bit color mode **Scan Mode:** Normal for standard photographic images, Quality for high definition images such as x-rays, Quality mode results in a slower scan speed
- 6 Options: User Defined Start Number:** Allows for more custom numbering of the files
- 7 File Type:** **TIF;** Full uncompressed image, **JPG;** uses JPG compression to reduce the file output size JPG only supports 8 bit image output
- 8 OK:** Saves the settings applied and closes this window
- 9 Reset:** Resets the software to ALL Factory Defaults
- 10 Cancel:** Closes this window and no settings will be saved

Advanced Settings Reference

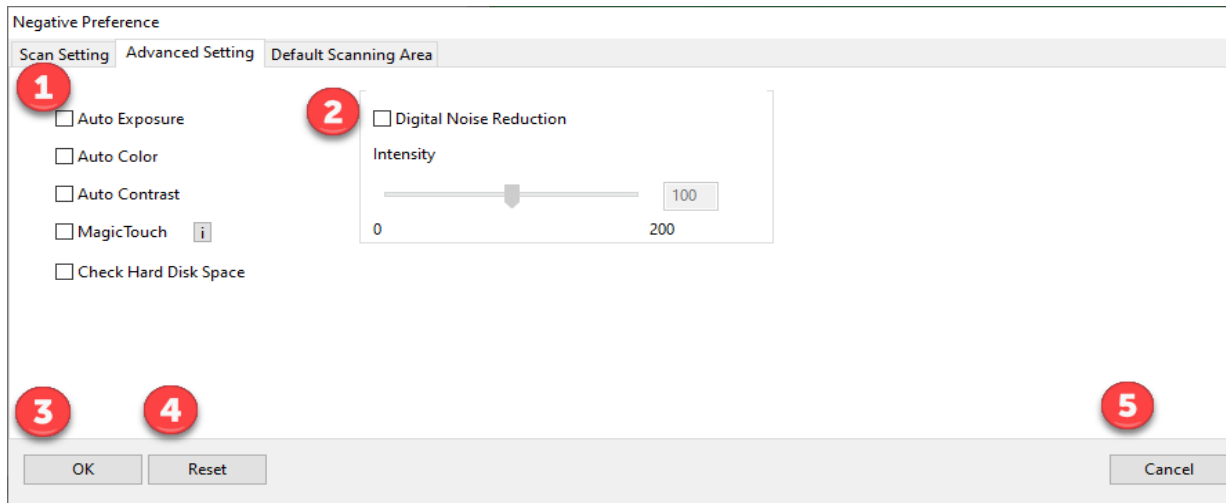

1

Auto Exposure: Automatically adjusts the image exposure, on by default
Auto Color: Corrects image colors when activated
Auto Contrast: Adjusts image contrast when enabled
Magic Touch: Removes dust and scratches when enabled

2

Digital Noise Reduction: This reduces digital film grain on higher speed films, do not use on 100 aa or slower as it will cause image degradation

3

OK: Saves settings and returns to main interface

4

Reset: Restores factory defaults on ALL Settings

5

Cancel: Closes settings and returns to main interface without saving changes

Default Scan Area Reference

Positive Preference

Scan Setting | Advanced Setting | Default Scanning Area

1 Enable user setting for auto-crop

	Width	Height	
Scan Size	<input type="text" value="3.649980"/>	<input type="text" value="2.429764"/>	<input type="button" value="Default"/>
Scan Offset	<input type="text" value="0.000000"/>	<input type="text" value="0.000000"/>	<input type="button" value="Default"/>

2 **3** **4**

- 1 Enable user setting for auto-crop:** This allows you to configure a smaller than standard 35mm scan area so it applies the same to every scan, this can be useful when scanning 110 slides, it cannot be set outside the 36.5 x 24.5 maximum scanning area, so there is no ability to capture the film sprocket area outside these dimensions
- 2 OK:** Returns you back to the main software interface and saves your settings
- 3 Reset:** Restores ALL settings back to factory defaults
- 4 Cancel:** Returns you back to the main software interface without saving your settings

Scan

Prescan – Prescan Current or Prescan ALL (strip 3 -40)

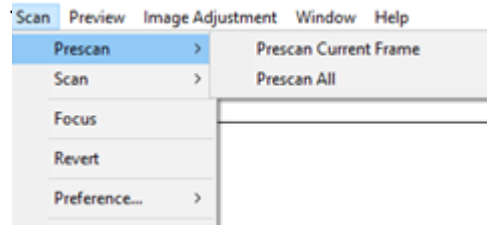

Prescanned images appear here, **NOTE:** Scanned images DO NOT appear in the CyberView window



Scan - Scan-

Scan Current Frame: Scan current image in the viewing window

Scan selected: images chosen from strip

(if you performed an optional Prescan) Example 1 & 3 selected

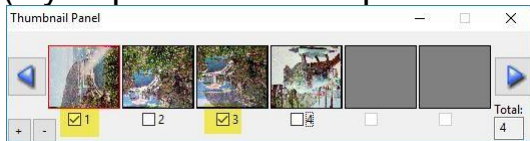

Scan ALL: Scan all frames in the strip 3-40 frames

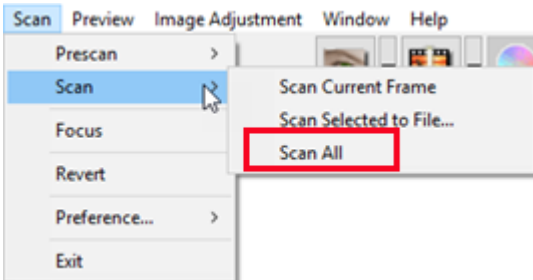

Calibrating

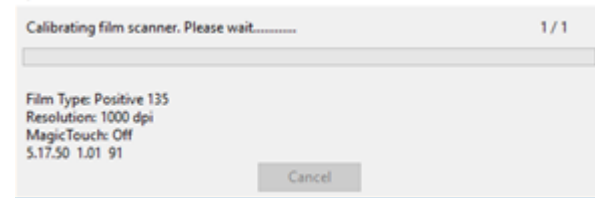

Measuring the films density



Scanning

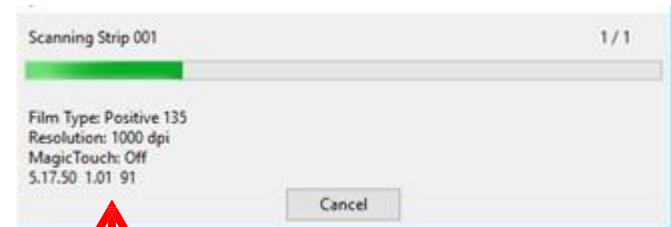

Scanning stats:
Film Type selected
Scan dpi
Scratch removal
Software / Firmware / Hardware version

USER INTERFACE

The screenshot displays the CyberViewX5-Plus software interface. The main window features a menu bar (Scan, Preview, Image Adjustment, Window, Help) and a toolbar with various icons. The central area is the 'Main Preview Area', which is currently empty. To the right, the 'Active Frame Setting' panel is open, showing settings for Scan Mode (Quality), Width (2500 DPI), Height (1.44), and Color Depth (8 bit). Below these are buttons for 'Apply to All' and 'Advanced >>'. The 'Information' section shows the file location 'C:\Users\Wendy\Pictures\'. A 'Thumbnail Panel' is visible at the bottom left, showing a row of six thumbnails and a 'Total: 0' indicator. Red arrows point from text annotations to specific UI elements: one points to the 'Main Preview Area', another to the 'Advanced >>' button, a third to the 'Open File Location' button, and a fourth to a thumbnail in the 'Thumbnail Panel'.

Main Preview Area

Active Frame Setting
Set Dpi
Color Depth
View image measurements

Advanced: Custom output settings

Open File Location,
opens the folder
directory set in the
settings area, for
image file viewing

Prescan thumbnail panel
Images only appear here
when prescan is used

Thumbnail Panel

Total: 0

There are four major parts of the CyberView X5-Plus user interface:

I. Main Window Area [Fixed Windows]

II. Preview Window Area [Fixed Window]

III. Active Frame Setting Area [Floating Window]

I. Main Window Area [Fixed Windows]

Menu Commands - Scan

Prescan - Prescan Current Frame: Pre-scan the existing slide.

Scan - Scan Current Frame - Scan Selected to File - Scan All

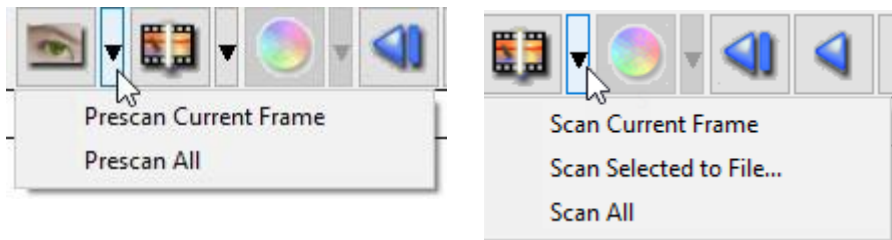

Menu Commands - **Preview** (*overview*)

Zoom, Rotate and flip features.

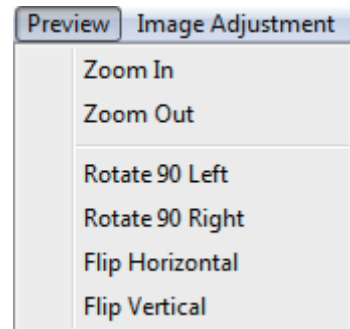

Preference - See Scan Setting (See Page 13) Exit

Closes the CyberView X5-Plus user interface.

Menu Commands - Image Adjustment

a. Image Adjustment

1. Variations: Generates different views of image with options to make changes to highlights, mid-tones, etc.

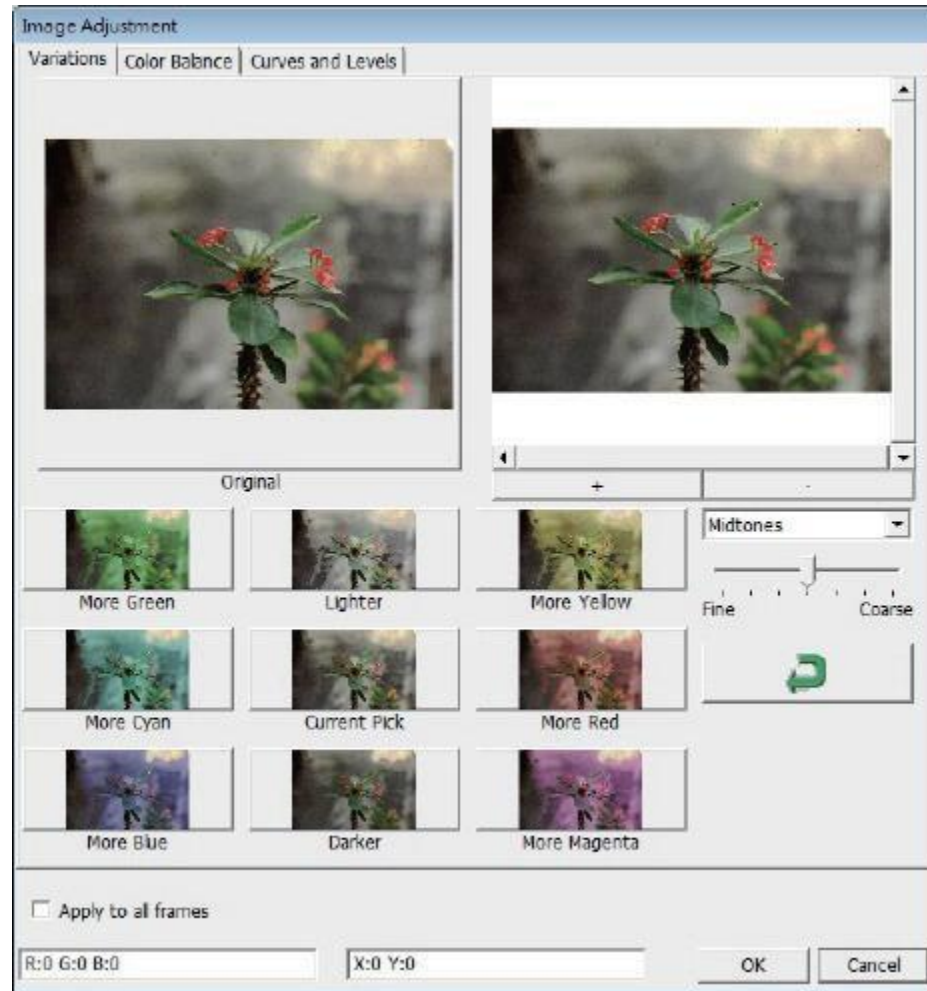
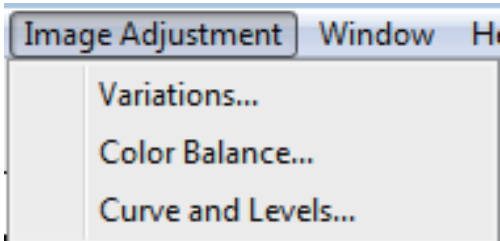

2. Color Balance

To adjust the brightness, contrast, saturation, and color (CMY or RGB) of the image. Comparisons between before and after adjusted images are shown for reference



Example: If a previewed image appears too dark, use the “Brightness” slider in the “Color Balance” window to adjust the image by selecting the slider in the center and moving it to the right. The image’s “After” view becomes lighter. Select “OK” to accept the changes which will be sent to the scanning hardware. This can also be used to adjust each of the functions in “Color Balance” by contrast, saturation and specific color ranges of cyan, magenta and yellow.

3. Curves and Levels

Adjust image settings by moving Curve and Levels settings. Comparison between before and after adjustment is displayed for reference.

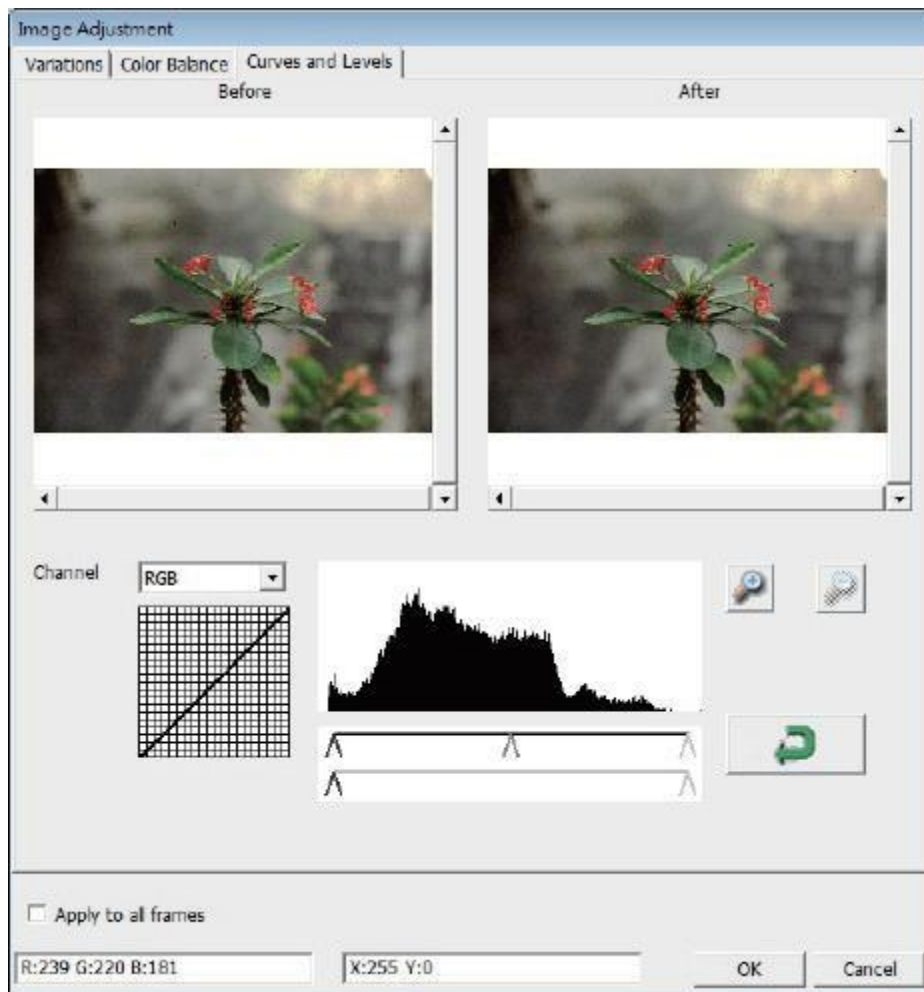

Example: When the previewed image appears to be too dark, adjustments with the Input slider in the Curves and Levels window can be made to correct the image. Selecting the Gray slider in the center and moving it to the left will result in changes in the “After” view resulting in a lighter image. Once the adjusted image is acceptable select “OK” to send changes to the scanning hardware. The same method can also be used to adjust each color channel independently, using the channel drop down menu “RGB = All colors” R = Red, G = Green, and B = Blue.

II. Preview Window Area [Fixed Windows]

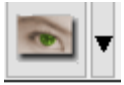

Prescan: Pre-scans the current film, or press drop down for more options.



Scan: Scan film, begins the scan process or press drop down button for more options



Image Adjustment: Accesses the image adjustment area after a Prescan has been performed Press drop down button for more options.



Left Return arrow: Ejects the film to the left



Left arrow: Reverses the film one frame to the left



Right arrow: Advances the film one frame to the right



Right return arrow: Ejects the film to the right



Go To:... You can select which frame to move to in the strip



Preference : Accesses the scan settings area

CyberView X Plus Left Tool bar diagram

These tools become available when an image is prescanned first

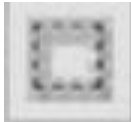

Crop Tool: Select scan area: more than one selection can be made at a time.



Zoom In: To magnify the image where the cursor is currently located. The image will be magnified with every click until the maximum multiple (1000%) is reached.



Zoom Out: To reduce the size of the viewed image click the Zoom Out cursor to the desired area, the image will reduce by half with every click until the lowest multiple (25%) is reached.



Rotate 90 Left: To rotate the image counter clockwise 90 degrees.



Rotate 90 Right: To rotate the image clockwise 90 degrees.



Flip Horizontal: To Flip the image 180 degrees horizontally.



Flip Vertical: To Flip the image 180 degrees vertically.

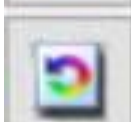

Revert: Discard all modifications and restores the image back to the original state in preview windows.

II. Preview Window Area [Fixed Windows] (Continued...)

Image Alignment Tool



Frame adjustment tool (TAB S) if your film is miss aligned after insertion you can use these TAB S on the ruler to adjust alignment by dragging the TAB to align with the edge of the film frame



You can select the ruler measurement unit "in"-"cm"-"px" by clicking the upper left corner.

Status Line

In the lower left hand corner, the color level (RGB: red, green, blue) and coordinates of the location [ex: I] are displayed. The zoom scale, the current frame location and how many areas selected to scan (if you see Selections 2 or higher indicates: Multiple scan areas on one slide [ex: II]).



III. Active Frame Settings : [Floating Windows] **Quality / Fast:** [ex: I] Input the basic parameter to scan (including scan resolution, film size, color depth).

Fast vs. Quality is the speed at which the scan head passes over the image, Quality for more detailed scans

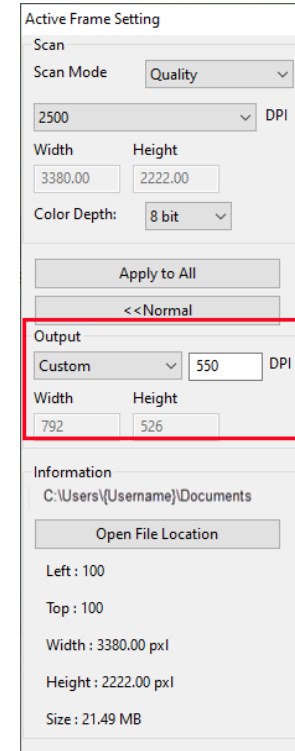
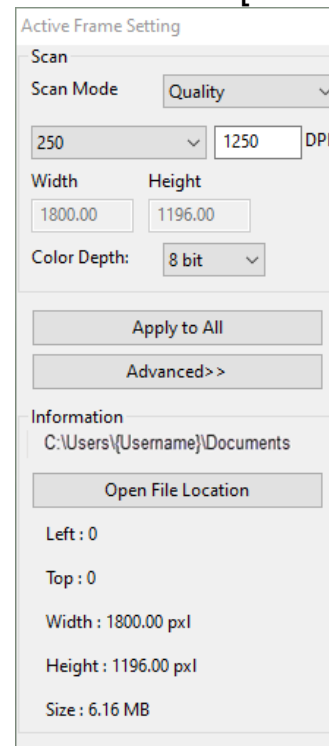

Example of print output sizes: Using Custom output settings
10,000 dpi scan, set to 300 dpi output would produce a 45" x 29.6 image
5,000 dpi you would get a 24" x 15.9" image
2,500 dpi you would get a 11.2" x 7.4"

Advanced mode: [ex: II] Allows you to input the parameter of **scan output**, **print size** resolution

Apply to All : Applies settings made in this window only to all frames

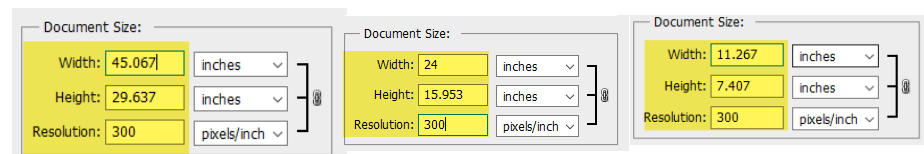

III. Active Frame Settings [Floating Windows] Normal (continued...)

Scan Mode:

Fast: Scans 30% faster

Quality :

Scans slower for more detailed images such as optical and dental x-rays

DPI: Set your scanning resolution

Color Depth: 8 or 16 bits per color Channel, resulting in a 24 or 48 bit image

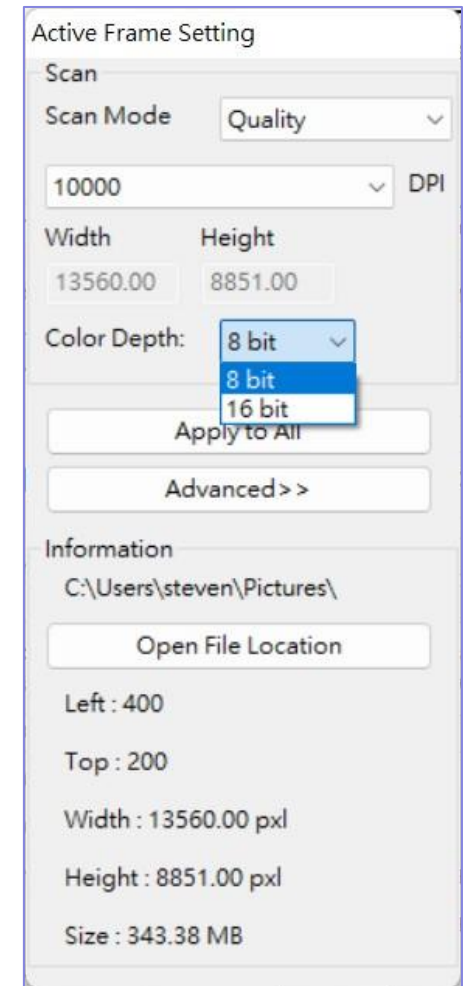
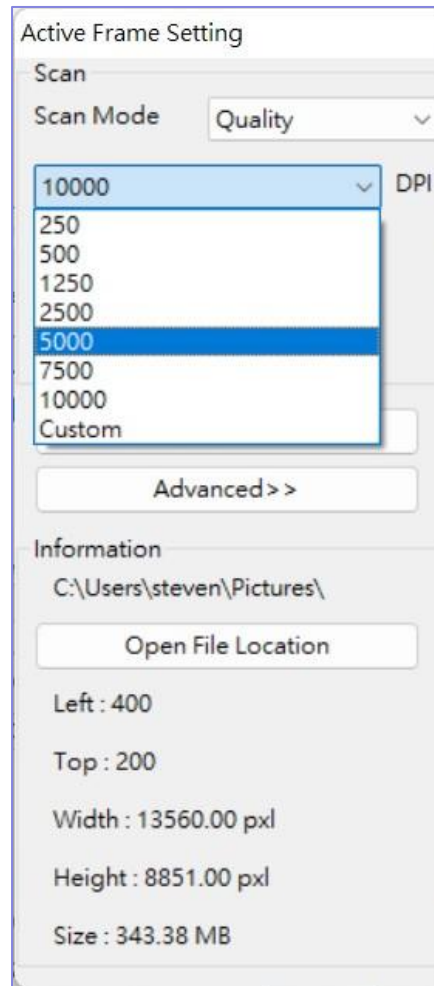
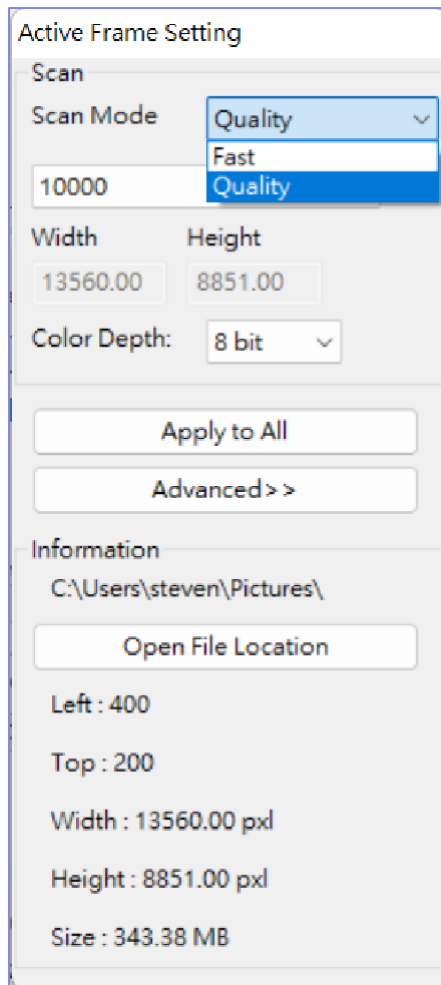

IV. Thumbnail Panel Area [Floating Windows]

Images only appear here in Prescan mode, scan to file goes directly to the hard drive, this window remains blank as does the main CyberView window.

Displays thumbnail view of pre-scanned images. By default all pre-scanned images are selected. Note the small check mark below the image.

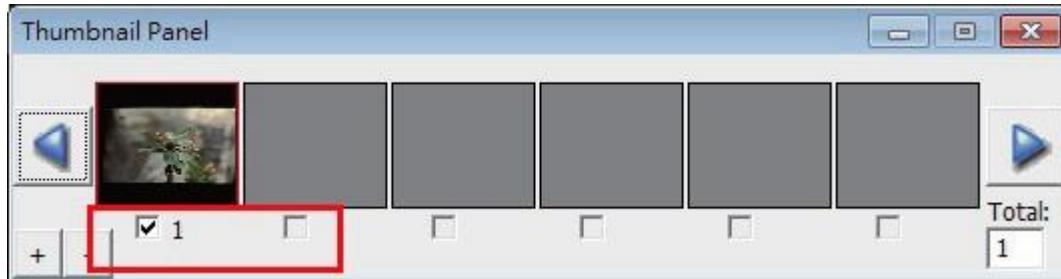

When scanning more than 6 frames (6 at a time are viewable in the thumbnail panel) you may scroll to view more by clicking on the right arrow button. The left / right arrow buttons allow you to scroll through pre-scanned images with ease. This model scanner is capable of scanning an entire roll of (uncut) film up to 40frames

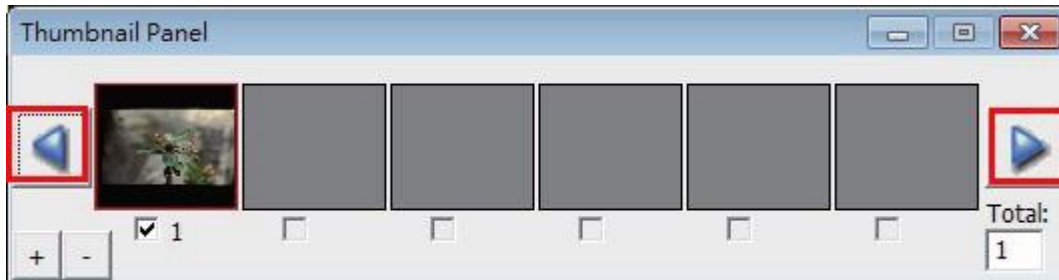

To de-select frames you do not wish to scan click on the check mark box to remove selection.

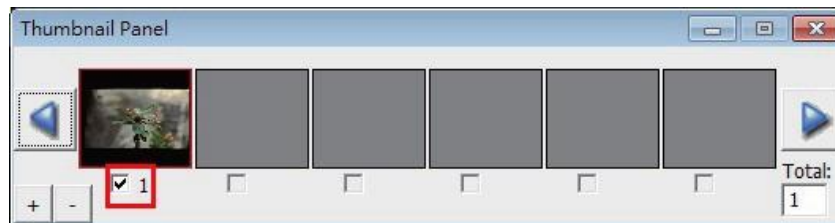

Basic Quick Scanning or once you have the Settings configured to your liking

1. Turn on scanner wait for green to come on solid, indicating it is fully warmed up
2. Open the Cyberview X application and you are ready to **scan**

NOTE: If the scanner sits quietly for 10-15 minutes it will go to sleep and lose communication

TO FIX THIS: You must Close Cyberview X, Turn off the scanner, wait 10 seconds, turn on the scanner and then wait for the full warm up to a solid green or blue light before starting the Cyberview software again.

General Settings Configuration

Choose the Film Type you wish to scan



Click down arrow to select Positive, Negative or B&W Film option

Go to Scan – Preference – Select Film type you are scanning

Positive (for color & B&W slides)

Negative (for color filmstrips)

B&W (for black & white negatives)

SLIDES

COLOR NEGATIVES

B&W NEGATIVES

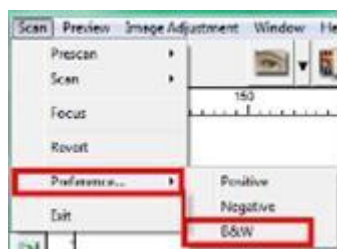
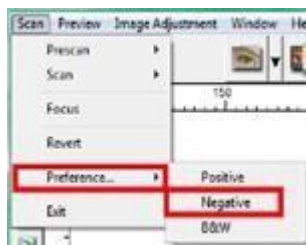
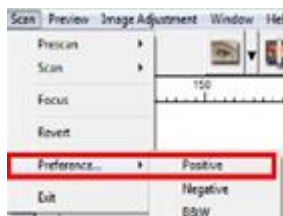

This area is where you will set up your desired configuration settings

Pre-Scan Resolution This only applies if you are prescanning every slide before the final scan, the higher dpi here offers a larger image in CyberView preview window (when you expand the window size) for prescan editing, to see the larger dpi sample please open the cyberview window to full screen

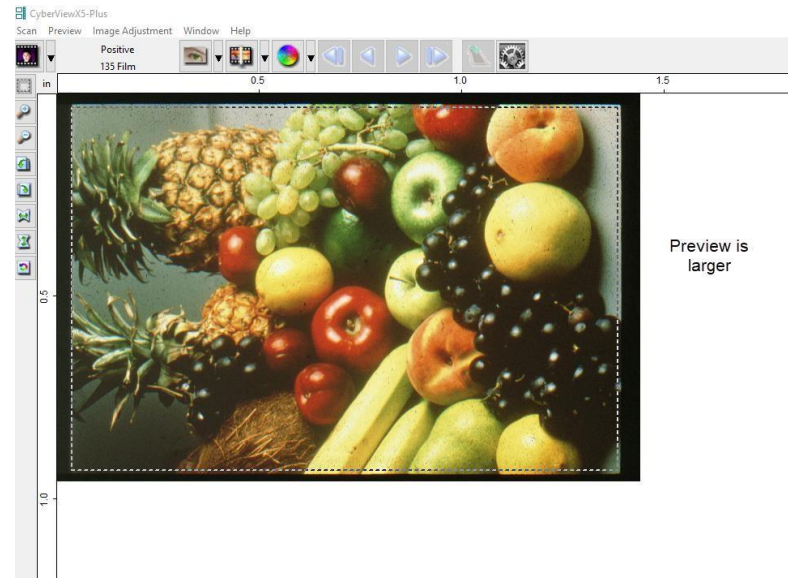
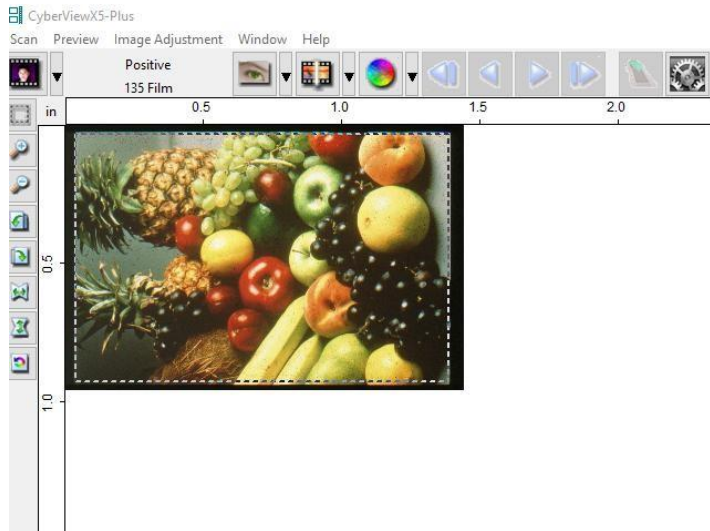

Directory: C:\Users\your name\Documents

Base File Name: image Browse...

To change the Default Save to location select **BROWSE**

Base File Name is the name each file will be given with an automatic number following

User Define Start number – This allows custom numbering also you can save these settings to pick up where you left off next time, to do so

Base File Name: image

Trailing Index after Base File Name

Digits: 3

Trailing Index after base file name Digits X - Is the number of digits you would like in your file naming sequence, default number is 3 - Image**001**, you can select 1-6 digits for this which would result in naming as follows Image1, Image01, Image001, Image0001, Image00001, Image000001 – this can be changed at any time

Example: Image001 is the default so the files will be named Image001, Image002 and so on, You can customize this to a name of your choosing to aid in organization, we recommend you add an Underscore_ after the base name, this will separate the name from the file number

Example: Base File name Germany_ would result in file names Germany_001, Germany_002 **Or Slides_** then the names would be Slides_001, Slides_002 the underscore leaves a nice separation from the number of the file, another option is to use years

1970_ then the file names would be 1970_001, 1970_002, 1970_003 etc.

File Type

TIF – Uncompressed best quality – Best used when you want to post edit the scans before burning to DVD etc. provides the most data to work with

JPG - Compressed – Compression is advanced making the files small – compresses and discards much of the original scanned image data during the save process

EXAMPLE an 1000 dpi, 8 bit (billions of colors) TIF image is approximately 3.83 MB, selecting the JPG 100 will give you a less than 786 kb image from that original 3.83 MB and if you select 16 bit color (trillions of colors) the TIF would be 7.87 MB vs the same 786 kb for JPG, because JPG compression does not support 16 bit color option.



Item type: JPG File
Rating: Unrated
Dimensions: 1308 x 885
Size: 786 KB



Item type: JPG File
Rating: Unrated
Dimensions: 6560 x 4441
Size: 16.2 MB

Inserting Film & Slides

This model scanner is capable of batch scanning negative strips of 4 or more and roll film up to 40 frames

NOTE: Do not insert film frames with less than 4 frames as they can become lodged in the scanner and may not be removable, requiring the unit to be sent in for service.

35mm Film Negative strips/Rolls

These films are to be inserted EMULSION side up, this is the dull side of the film, this will result in backward scans due to the internal design of the scanner, to have these scan correctly when using Cyberview X you MUST prescan all the frames and then select the Flip function for each individual frame, if you choose to use 3rd party scanning software "VueScan" it has the ability to perform this mirror function automatically.

The film gets inserted into the unit about 2 frames before the automatic motor will grab and feed the strip/roll in automatically, the toolbar selections will now become active once a film of slide is inserted, and not before



FILM/SLIDE Inserted Tools are now activated for use

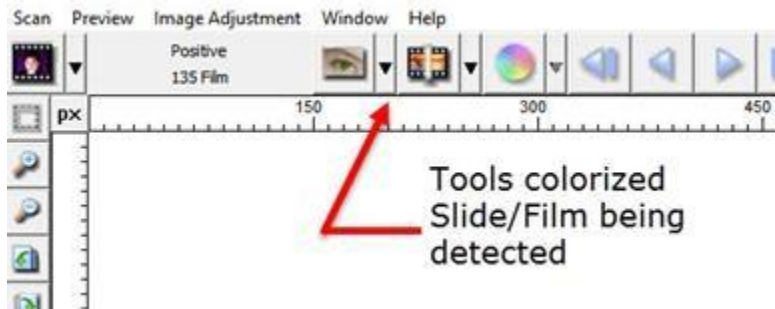

Adjusting the first frame for proper scan alignment for the entire strip/roll

Once the film is inserted and detected you can align the frame either by viewing it through the view window on the top of the unit, or by prescanning the first frame and using the software to align the film.

To use the viewing window, look into the window to see if the negative frame is aligned in the center, if not you can use the buttons on top of the unit to make slight adjustments, by quickly pressing the button to move forward or reverse, be careful as pressing too long will cause the unit to advance/reverse an entire frame instead of making an incremental adjustment, a more accurate method would be to pre-scan the first frame

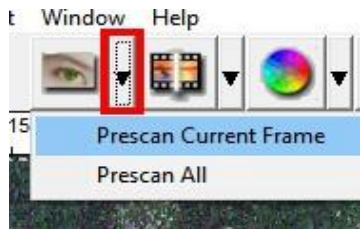
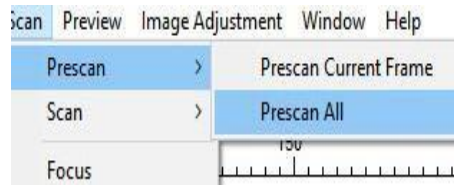
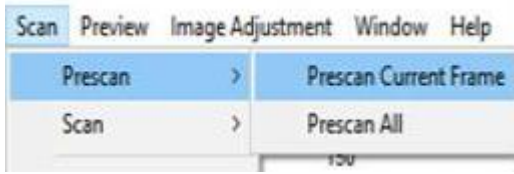

For this film example I would use the right Tab adjustment and move it to the left, once you release the mouse button the scanner motor will automatically begin re-aligning the film, The tab was moved to the edge of the film where the image ends

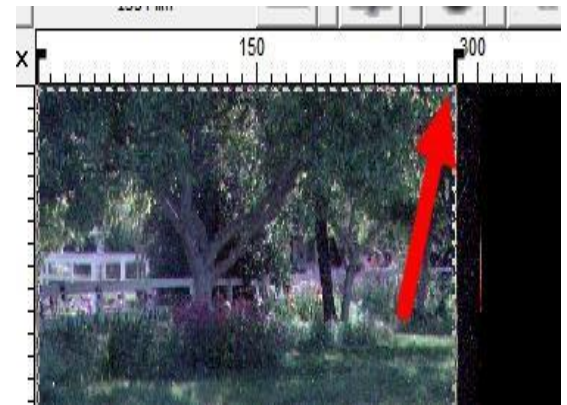

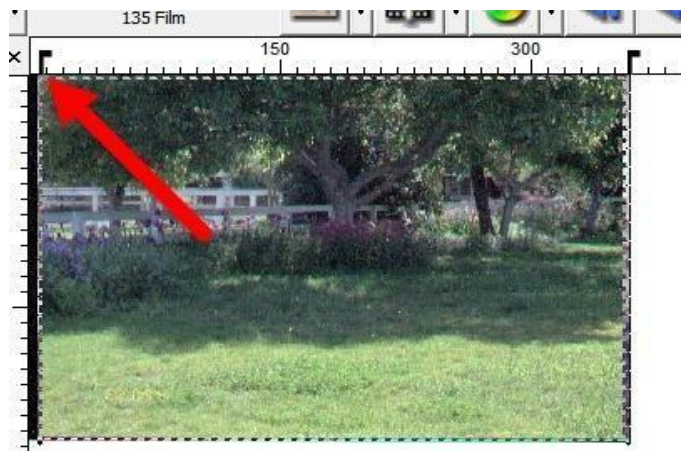

Aligned frame

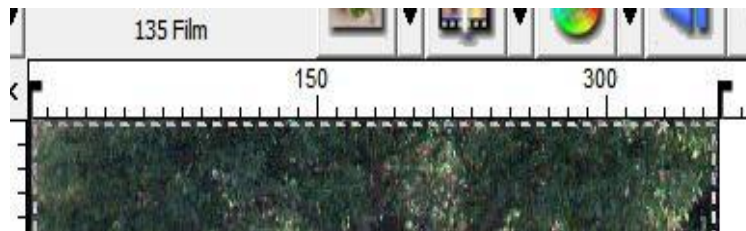

You can now proceed with a batch scan by selecting the Scan All option as the frames are now aligned, or simply select to scan this one frame to file.

NOTE: Some films especially certain B&W films may not feed properly due to how the film was processed during development causing the auto feed and alignment features to not function correctly, for these films you will need to prescan and manually align each frame individually.

Connectivity issues with my new scanner

Q: My scanner keeps producing Unable to communicate errors, sometimes it does connect only to hang up on Calibrating, I am using Windows 10 how can I resolve this?

A: Please be sure the scanner is in the ready state the power light will be on solid after it completes the startup calibration.

If using on a desktop PC that you are only connecting to a rear USB port, and you are not using any USB extension cables.

If the PC has both USB 2.0 and USB 3.0 ports please use the USB 2.0 for better connectivity, if however the PC only has USB 3.0 then it may be necessary to use a hub between the scanner and the PC due to the differences in the hardware design

USB hubs have IC component to reconfigure the USB signal which can alleviate signal distortion that causes connectivity issues

Best option would be to use a USB 2.0 hub on the 3.0 port, if you do not have a 2.0 hub then a 3.0 hub will work

Making my scanner work with Mac

Q: My scanner hangs on initializing scanner, I am running a Mac with the latest OS

A: Please be sure the scanner is in the ready state the power light will be on solid after it completes the startup calibration.

Please Note: If the Mac has the new USB-C mini ports requiring an adapter to fit standard USB devices, there have been connectivity issues using these types of connections

TECHNICAL SUPPORT

CyberView

For more information on our film scanners, please visit [Pacific Image Electronics](#)

For Support and driver updates

[Driver updates](#)

[Contact Us](#)